

# Shelving Price List



EFFECTIVE JANUARY 1, 2015

This price list supersedes all previous price lists.  
Prices subject to change without notice.

Main Office: (800) 251-8184 \* FAX: (800) 722-0134  
Customer Service: (615) 446-8686  
Website: www.tennsco.com \* E-mail: info@tennsco.com

MAILING ADDRESS: P.O. Box 1888, Dickson, TN 37056-1888

SHIPPING ADDRESS: 201 Tennsco Drive Dickson, TN 37055

## CONTENTS:

PAGE 2: Policies, Services and Warranty

### **Z-Line Boltless Shelving and Rack:**

PAGE 3: Shelf Supports

PAGE 4: Deck Supports and Upright Posts

PAGE 5: Particleboard, Wire Decking

PAGE 6: Steel Shelving, Doors/Sides/Backs and Accessories

PAGE 7: Aisle/Wall Ties, Hang Rods and Accessories

PAGE 8: Record Archive and Steel Shelving Units

PAGE 9: Sloped Shelving Units, Die Rack Units

PAGE 10: Low Profile Shelving Units

PAGE 11: Long Span Shelving Units

### **Logic Shelving:**

PAGE 12: Wire Shelving, Mobile Carts, Casters

PAGE 13: Miscellaneous Accessories

### **Q-Line Industrial Shelving:**

PAGE 14: Open Style Units, Hinged Door Units

PAGE 15: Closed Style Units, Ledge Units

PAGE 16: Shelves

PAGE 17: Posts, Uprights, Shelf Clips, Label Holders

PAGE 18: Bin Components, Sway Braces and Plates

PAGE 19: End and Back Panels, Sliding Dividers, Foot Plates

PAGE 20: Miscellaneous Accessories

### **Automotive Shelving:**

PAGE 21: Preconfigured Units and Components

### **Bulk Storage Shelving:**

PAGE 22: Upright Frames, Spacers, Extensions

PAGE 23: Decking, Beams and Misc. Components

PAGE 24: Wire Decking Components

### **Slotted Angle:**

PAGE 24: Slotted Angle

**NOTE: ALL UNITS REQUIRE ASSEMBLY.**

UNLESS OTHERWISE INDICATED, ALL ITEMS ARE AVAILABLE IN  
MEDIUM GREY, LIGHT GREY & SAND.

NATIONAL MOTOR FREIGHT CLASSIFICATION ON ALL ITEMS EXCEPT  
PARTICLE BOARD; **LTL CLASS 70; TL CLASS 35.**

NATIONAL MOTOR FREIGHT CLASSIFICATION ON PARTICLEBOARD:  
**LTL CLASS 50; TL CLASS 55.**



Z-Line



Q-Line



Bulk



Automotive



Logic

## TENNSCO QUICK-SHIP PROGRAM

**NEED AN ORDER FAST? Look for the ♦ logo throughout the book.**

Many of Tennsco's top items are available to ship in 2 days.

Quick Ship inventory is available in limited quantities and select colors. For larger orders, please contact customer service for availability.





### POLICY AND SERVICES

**PRICING:** All prices are F.O.B. Tennsco Corp's Facility in Dickson, Tennessee. All orders are subject to final acceptance at the Home Office, Dickson, Tennessee. Prices subject to change without notice. Tennsco has the right to make product design changes at any time. Tennsco's prices do not include sales, use, excise or similar taxes. Consequently, in addition to the prices specified herein, the amount of any present or future sales, use, excise or similar tax applicable to the manufacture, sale, purchase or use of the goods sold hereunder shall be paid by Buyer. In lieu thereof, Buyer shall provide Seller with a tax exemption certificate acceptable to the applicable taxing authorities.

**TERMS OF PAYMENT:** Terms are Net 30 Days from date of shipment. A service charge of 1 1/2% per month will be charged for overdue invoices.

**MINIMUM ORDERS:** Minimum order is \$15.00.

**SPECIFICATIONS:** Tennsco reserves the right to change any product specifications contained in this price list.

**FREIGHT CHARGES:** All shipments will be made freight collect unless otherwise specified. If freight is prepared, it will be added to the invoice or billed separately, depending on arrangements. On shipments by parcel post, the postage will be added to the invoice. All routing will be done solely by the Home Office. If purchaser does not accept delivery of merchandise when ready for shipment, storage fees will be charged to the purchaser.

**WEIGHT:** Weights shown are approximate.

**FREIGHT CLAIMS:** Claims for shortages must be made in writing to the Home Office within 5 business days from receipt of shipment. Claims for damaged or lost material must be filed with the carrier.

**CAUTION:** When you give delivering carrier a clear receipt for a shipment in which there is damaged merchandise or a shortage, the carrier is relieved of further responsibility. Claims for damage or shortage must be filed by you with the delivering carrier. Tennsco will not accept return of merchandise damaged in transit. Your claim is with the delivering carrier.

**PARTIAL SHIPMENTS:** Tennsco reserves the right to make delivery in installments unless otherwise expressly stated herein. All such installments shall be separately invoiced and paid for when due, without regard to subsequent deliveries. Delay in delivery of all installments shall not relieve Buyer of its obligations to accept remaining deliveries.

**SHIPPING TIME:** Shipping dates are estimates only, based on standard manufacturing times. Tennsco makes every effort to meet shipping date requests, but will not be held liable for missed shipping dates. Once items are shipped, Tennsco is not responsible for delays caused by the delivering carrier. This includes, but is not limited to, delays in installation proceedings due to slow delivery by carrier.

**CANCELLATIONS & RETURNS:** Orders for "Special" items are not subject to change or cancellation. No return merchandise will be accepted without written consent of the General Office, Dickson, Tennessee. All returned shipments are subject to a handling charge of 25% plus all transportation charges incurred by Tennsco unless Tennsco is at fault. Once production of "Special" items has begun, cancellation of order is subject to Tennsco approval. A 15% surcharge will be assessed to approved cancelled items.

**CODE RESTRICTIONS:** Local building codes vary. It is the purchaser's responsibility to determine that product installation is in accordance with local requirements.

### LIMITED WARRANTY

Tennsco warrants goods purchased hereunder to be free of defects in materials and workmanship for a period of one (1) year from the date of shipment, hereunder. Tennsco's warranty shall not apply in the event goods are damaged as a result of misuse, abuse, neglect, accident, improper application, modification or repair by persons not authorized by Seller, where goods are damaged during shipment. UNLESS CONSIDERED UNENFORCEABLE OR UNLAWFUL UNDER APPLICABLE LAW:

- a. ALL IMPLIED WARRANTIES, INCLUDING BUT NOT LIMITED TO WARRANTIES OR MERCHANTABILITY AND FITNESS FOR A PARTICULAR PURPOSE ARE HEREBY EXCLUDED.
- b. BUYERS REMEDY, IF ANY, FOR ANY DEFECTIVE GOODS SHALL BE LIMITED TO A REFUND BY SELLER OR REPLACEMENT OF THE GOODS AT SELLER'S OPTION AND SHALL IN NO EVENT INCLUDE DAMAGES OF ANY KIND, WHETHER INCIDENTAL, CONSEQUENTIAL OR OTHERWISE.

NO GOODS ACCEPTED FOR RETURN WITHOUT PRIOR APPROVAL. Seller shall have the right to inspect any goods claimed to be defective at Buyer's place of business or require Buyer to return the goods to Seller for inspection on Seller's premises. Transportation charges covering returned goods will be borne by Seller only if such goods are proven to be defective, are covered by this warranty and are returned within the warranty period stated above.

# Z-LINE COMPONENTS

## Shelf Supports

Look for the red diamond!

### SEISMIC SUPPORT CHANNEL

♦QUICKSHIP COLORS: Sand and Medium Grey

CAT. NO.	LOAD CAP.*	RECOMMENDED # SUPPORTS	LENGTH	WT.	PRICE
<b>SEISMIC SUPPORT CHANNEL</b>					
SSC-36	2750	1	35.5	4.7	15.70
SSC-48	2500	1	47.5	6.3	20.00
SSC-60	2250	1	59.5	7.9	25.00
SSC-72	2000	2	71.5	9.5	29.00
SSC-84	1750	3	83.5	11.1	33.00
SSC-96	1600	3	95.5	12.7	38.00
<b>EXTRA HEAVY-DUTY SHELF SUPPORTS</b>					
LRC-48♦	2500	1	47.5	5.2	15.00
LRC-60	2250	1	59.5	6.2	20.00
LRC-72♦	2000	2	71.5	7.4	22.00
LRC-84	1750	3	83.5	8.7	27.00
LRC-96♦	1600	3	95.5	9.9	29.00
<b>HEAVY-DUTY SHELF SUPPORTS</b>					
LRA-12♦	2250	—	11.5	0.9	3.80
LRA-15♦	2250	—	14.5	1.2	4.50
LRA-16	2250	—	15.5	1.3	4.90
LRA-18♦	2250	—	17.5	1.4	4.90
LRA-24♦	2250	—	23.5	1.9	6.10
LRA-30♦	2250	—	29.5	2.3	7.40
LRA-32	2250	—	31.5	2.5	8.90
LRA-36♦	2250	—	35.5	2.8	8.90
LRA-42*♦	2250	1	41.5	3.3	10.60
LRA-48♦	2250	1	47.5	3.7	11.30
LRA-60♦	2000	1	59.5	4.7	14.20
LRA-69*♦	1800	1	68.5	5.4	16.30
LRA-72♦	1750	2	71.5	5.7	18.70
LRA-84♦	1500	3	83.5	6.6	24.00
LRA-96♦	1250	3	95.5	7.5	25.00
<b>MEDIUM DUTY SHELF SUPPORTS (16 GAUGE)</b>					
VDRS-1216	1000	—	11.5	0.6	2.90
VDRS-1516	1000	—	14.5	0.8	3.30
VDRS-1816♦	1000	—	17.5	0.9	3.80
VDRS-2416♦	1000	—	23.5	1.3	4.50
VDRS-3016♦	1000	—	29.5	1.5	5.60
VDRS-3616♦	1000	1	35.5	1.8	6.40
VDRS-4216♦	900	1	41.5	2.2	7.60
VDRS-4816♦	850	1	47.5	2.5	8.30
<b>MEDIUM DUTY SHELF SUPPORTS (14 GAUGE)</b>					
VDRS-4814	1000	1	47.5	3.6	13.30
VDRS-6014♦	750	1	59.5	4.6	15.30
VDRS-6614	700	1	65.5	5.0	16.50
VDRS-6914♦	650	2	68.5	5.2	17.10
VDRS-7214♦	600	2	71.5	5.4	18.70

\*Load capacities based on evenly distributed loads.

♦QUICKSHIP COLORS: Sand and Medium Grey

CAT. NO.	LOAD CAP.*	LENGTH	GA.	WT.	PRICE
<b>LOW PROFILE SHELF SUPPORTS</b>					
DRS-1214♦	600	11.5	14	0.5	2.70
DRS-1514♦	600	14.5	14	0.7	3.10
DRS-1814♦	600	17.5	14	0.9	3.50
DRS-2414♦	600	23.5	14	1.1	3.70
DRS-3014♦	600	29.5	14	1.4	4.50
DRS-3611♦	850	35.5	11	2.8	8.70
DRS-3614♦	600	35.5	14	1.7	5.20
DRS-4211♦	800	41.5	11	3.2	9.30
DRS-4214♦	550	41.5	14	2.0	5.90
DRS-4811♦	750	47.5	11	3.7	10.20
DRS-4814♦	500	47.5	14	2.3	6.60

\*Load capacities based on evenly distributed loads.

Shelf supports are 1 1/2" d x 4 13/32" h. Load capacities are based on above recommended number of SDS-dd front-to-back deck supports. Allows unit to be secured to floor in order to meet seismic requirements.

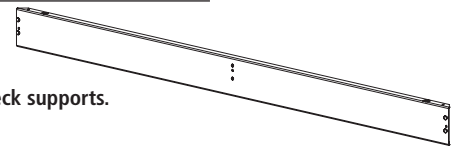

### SEISMIC SUPPORT CHANNEL

Shelf supports are 1" d x 3 1/4" h. Load capacities are based on above recommended number of SDS-dd front-to-back deck supports. Use left to right only; not to be used front to back. Cannot be installed in bottom two keyholes of uprights; Will not sit flush on the floor.

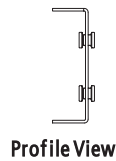

### EXTRA HEAVY-DUTY SHELF SUPPORTS

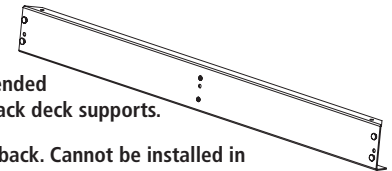

Shelf supports are 1" d x 2 3/4" h. Load capacities are based on recommended number of SDS-dd front-to-back deck supports. \*42" and 69" sizes are slotted for optional use of archive box rails (ZBR-dd).

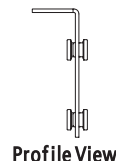

### HEAVY-DUTY SHELF SUPPORTS

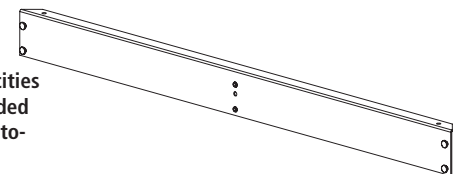

Shelf supports are 7/8" d x 2" h. Supports slotted for optional FBSV-dd front-to-back deck supports. Load capacities are based on recommended number of deck supports.



### MEDIUM DUTY SHELF SUPPORTS



Shelf supports are 7/8" d x 2 1/4" h. Supports slotted on 12" centers for optional FBSV-dd front-to-back deck supports. Load capacities are based on recommended number of deck supports.



Shelf supports are 27/32" d x 1 1/8" h.

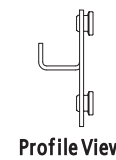

### LOW PROFILE SHELF SUPPORTS

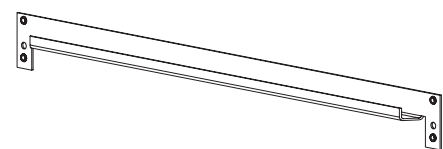

# Z-LINE COMPONENTS

## Deck Supports and Upright Posts

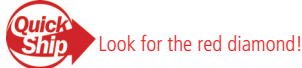

### FRONT-TO-BACK DECK SUPPORTS

◆ QUICKSHIP COLORS: Sand and Medium Grey

CAT. NO.	W	D	H	WT.	PRICE
<b>HEAVY-DUTY DECK SUPPORTS (FOR LRA, LRC &amp; SSC)</b>					
SDS-12◆	7/8	12	2 11/16	1.0	<b>3.00</b>
SDS-15◆	7/8	15	2 11/16	1.2	<b>3.50</b>
SDS-16	7/8	16	2 11/16	1.3	<b>4.20</b>
SDS-18◆	7/8	18	2 11/16	1.4	<b>4.20</b>
SDS-24◆	7/8	24	2 11/16	1.9	<b>5.10</b>
SDS-30◆	7/8	30	2 11/16	2.4	<b>6.50</b>
SDS-32	7/8	32	2 11/16	2.5	<b>7.30</b>
SDS-36◆	7/8	36	2 11/16	2.8	<b>7.30</b>
SDS-42	7/8	42	2 11/16	3.3	<b>9.60</b>
SDS-48◆	7/8	48	2 11/16	3.8	<b>9.60</b>
<b>MEDIUM-DUTY DECK SUPPORTS (FOR VDRS)</b>					
FBSV-12	1 5/8	12	1 5/8	0.6	<b>3.60</b>
FBSV-15◆	1 5/8	15	1 5/8	0.8	<b>3.60</b>
FBSV-18◆	1 5/8	18	1 5/8	0.9	<b>3.90</b>
FBSV-24◆	1 5/8	24	1 5/8	1.3	<b>5.00</b>
FBSV-30◆	1 5/8	30	1 5/8	1.6	<b>5.60</b>
FBSV-36◆	1 5/8	36	1 5/8	1.9	<b>6.50</b>
FBSV-42	1 5/8	42	1 5/8	2.2	<b>8.80</b>
FBSV-48◆	1 5/8	48	1 5/8	2.5	<b>10.00</b>

### UPRIGHT POSTS

◆ QUICKSHIP COLORS: Sand and Medium Grey

CAT. NO.	W	D	LENGTH	WT.	PRICE
<b>STANDARD ANGLE POST</b>					
EUR-36◆	1 15/32	1 15/32	36	2.0	<b>6.50</b>
EUR-48◆	1 15/32	1 15/32	48	2.7	<b>9.00</b>
EUR-60◆	1 15/32	1 15/32	60	3.4	<b>10.20</b>
EUR-72◆	1 15/32	1 15/32	72	4.0	<b>12.20</b>
EUR-84◆	1 15/32	1 15/32	84	4.7	<b>14.10</b>
EUR-96◆	1 15/32	1 15/32	96	5.4	<b>16.20</b>
EUR-108◆	1 15/32	1 15/32	108	6.0	<b>18.60</b>
EUR-120◆	1 15/32	1 15/32	120	6.7	<b>20.00</b>
EUR-132	1 15/32	1 15/32	132	7.4	<b>23.00</b>
EUR-144◆	1 15/32	1 15/32	144	8.1	<b>24.00</b>
<b>INTERMEDIATE POST</b>					
ZTP-36	3 3/8	1 15/32	36	3.9	<b>13.50</b>
ZTP-48◆	3 3/8	1 15/32	48	5.1	<b>17.50</b>
ZTP-60◆	3 3/8	1 15/32	60	6.4	<b>21.00</b>
ZTP-72◆	3 3/8	1 15/32	72	7.7	<b>25.00</b>
ZTP-84◆	3 3/8	1 15/32	84	9.0	<b>29.00</b>
ZTP-96◆	3 3/8	1 15/32	96	10.3	<b>33.00</b>
ZTP-108◆	3 3/8	1 15/32	108	11.6	<b>37.00</b>
ZTP-120◆	3 3/8	1 15/32	120	12.8	<b>41.00</b>
ZTP-132	3 3/8	1 15/32	132	14.1	<b>45.00</b>
ZTP-144◆	3 3/8	1 15/32	144	15.4	<b>49.00</b>
<b>HIGH CAPACITY ANGLE POST</b>					
SUR-36	2 1/16	2 1/16	36	2.8	<b>9.20</b>
SUR-48	2 1/16	2 1/16	48	3.7	<b>12.40</b>
SUR-60◆	2 1/16	2 1/16	60	4.7	<b>14.40</b>
SUR-72◆	2 1/16	2 1/16	72	5.4	<b>17.10</b>
SUR-84◆	2 1/16	2 1/16	84	6.5	<b>19.90</b>
SUR-96◆	2 1/16	2 1/16	96	7.6	<b>23.00</b>
SUR-108	2 1/16	2 1/16	108	8.5	<b>26.00</b>
SUR-120◆	2 1/16	2 1/16	120	9.2	<b>28.00</b>
SUR-132	2 1/16	2 1/16	132	10.4	<b>32.00</b>
SUR-144◆	2 1/16	2 1/16	144	11.4	<b>34.00</b>
SUR-168	2 1/16	2 1/16	168	13.3	<b>40.00</b>
SUR-181.5	2 1/16	2 1/16	181.5	14.3	<b>43.00</b>

# Z-LINE COMPONENTS

## Particleboard and Wire Decking

Look for the red diamond!

### PARTICLEBOARD DECKING

◆ QUICKSHIP COLOR: Natural

CAT. NO.	W	D	H	WT.	PRICE
PB-3612◆	36	12	5/8	7.5	6.00
PB-3615◆	36	15	5/8	9.4	6.60
PB-3618◆	36	18	5/8	11.3	9.00
PB-3624◆	36	24	5/8	15.0	12.00
PB-3630◆	36	30	5/8	18.8	15.10
PB-3636◆	36	36	5/8	22.5	18.00
PB-4212◆	42	12	5/8	8.8	7.60
PB-4215◆	42	15	5/8	10.9	8.20
PB-4218◆	42	18	5/8	13.1	10.80
PB-4224◆	42	24	5/8	17.5	14.20
PB-4230◆	42	30	5/8	21.9	16.70
PB-4236◆	42	36	5/8	26.3	20.00
PB-4812◆	48	12	5/8	10.0	8.10
PB-4815◆	48	15	5/8	12.5	10.00
PB-4818◆	48	18	5/8	15.0	12.00
PB-4824◆	48	24	5/8	20.0	14.70
PB-4830◆	48	30	5/8	25.0	19.90
PB-4836◆	48	36	5/8	31.0	22.00
PB-4842◆	48	42	5/8	35.0	34.00
PB-4848◆	48	48	5/8	40.0	32.00
PB-6024◆	60	24	5/8	25.0	20.00
PB-6030◆	60	30	5/8	31.3	24.00
PB-6036◆	60	36	5/8	37.5	30.00
PB-6048◆	60	48	5/8	50.0	38.00
PB-6915◆	69	15	5/8	18.0	14.00
PB-6930◆	69	30	5/8	35.9	34.00
PB-7224◆	72	24	5/8	30.0	26.00
PB-7230◆	72	30	5/8	37.5	28.00
PB-7236◆	72	36	5/8	45.0	36.00
PB-7248◆	72	48	5/8	60.0	47.00
PB-8424	84	24	5/8	35.0	32.00
PB-8430	84	30	5/8	50.0	37.00
PB-8436	84	36	5/8	52.5	48.00
PB-8448	84	48	5/8	70.0	63.00
PB-9624◆	96	24	5/8	44.0	32.00
PB-9630◆	96	30	5/8	50.0	37.00
PB-9636◆	96	36	5/8	60.0	48.00
PB-9648◆	96	48	5/8	80.0	63.00

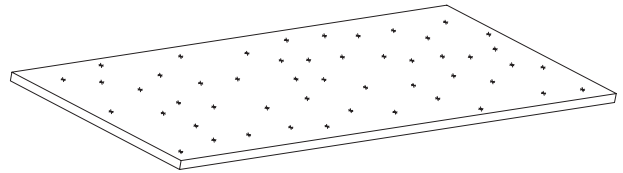

Industrial Grade

Industrial grade 5/8" thick particleboard provides a sturdy work surface that is both strong and economical.

◆ QUICKSHIP COLOR: Medium Grey

CAT. NO.	W	D	H	WT.	PRICE
ZWD-3612	36	12	5/16	4.0	23.00
ZWD-3618◆	36	18	5/16	6.0	28.00
ZWD-3624◆	36	24	5/16	8.0	36.00
ZWD-3636◆	36	36	5/16	12.0	49.00
ZWD-4218	42	18	5/16	7.1	41.00
ZWD-4224	42	24	5/16	9.3	46.00
ZWD-4230	42	30	5/16	11.7	52.00
ZWD-4236	42	36	5/16	14.2	52.00
ZWD-4812	48	12	5/16	5.4	26.00
ZWD-4815	48	15	5/16	7.0	40.00
ZWD-4818◆	48	18	5/16	8.0	32.00
ZWD-4824◆	48	24	5/16	10.7	42.00
ZWD-4836◆	48	36	5/16	16.0	59.00
ZWD-4848	48	48	5/16	21.0	85.00
ZWD-6024	60	24	5/16	13.3	70.00
ZWD-6036	60	36	5/16	20.0	83.00
ZWD-6048	60	48	5/16	27.0	116.00
ZWD-6930	69	30	5/16	19.2	78.00
ZWD-7224	72	24	5/16	16.0	64.00
ZWD-7236	72	36	5/16	24.0	89.00
ZWD-7248	72	48	5/16	32.0	99.00
ZWD-8424*	84	24	5/16	19.0	78.00
ZWD-8436*	84	36	5/16	28.0	104.00
ZWD-8448*	84	48	5/16	37.0	134.00
ZWD-9624*◆	96	24	5/16	21.0	84.00
ZWD-9636*◆	96	36	5/16	32.0	118.00
ZWD-9648*	96	48	5/16	42.0	170.00

### WIRE DECKING

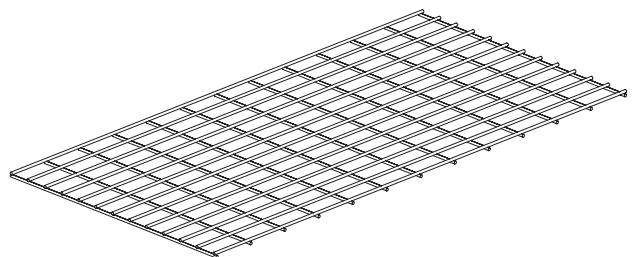

\*84" w and 96" w are two pieces tied together with zip ties. Wire decking uses 4 gauge wire & consists of a 2" x 4" mesh pattern. Additional sizes are available; contact factory for pricing. Wire decking is subject to longer than normal lead times; contact factory for specifics. Not recommended for shelf levels with DRS supports deeper than 24".

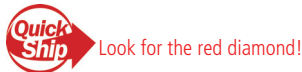

### STEEL SHELVES

Attaches to upright posts with four shelf clips per shelf (included). Shelf clips allow for access from all four sides of the unit.

NOTE: When building your own unit with steel shelves, you MUST use VDRS supports at the top and bottom of the unit, on all four sides for stabilization. Shelf clips alone are NOT sufficient to support unit.

In addition, units 96" and taller must use VDRS supports in the center of the unit, on all four sides.

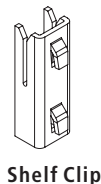
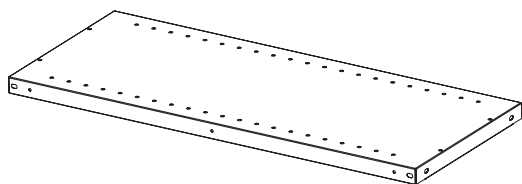

♦ QUICKSHIP COLOR: Medium Grey

CAT. NO.	GAUGE	W	D	H	WT.	PRICE
ZMS-3612♦	22	36	12	1 5/16	6.7	23.00
ZMS-3618♦	22	36	18	1 5/16	8.8	28.00
ZMS-3624♦	22	36	24	1 5/16	10.9	34.00
ZMS-3636♦	20	36	36	1 5/16	17.9	64.00
ZMS-4212♦	22	42	12	1 5/16	7.7	29.00
ZMS-4218♦	22	42	18	1 5/16	10.1	36.00
ZMS-4224♦	22	42	24	1 5/16	12.5	43.00
ZMS-4236♦	20	42	36	1 5/16	21.0	70.00
ZMS-4812♦	22	48	12	1 5/16	8.7	29.00
ZMS-4818♦	22	48	18	1 5/16	11.4	36.00
ZMS-4824♦	22	48	24	1 5/16	14.1	43.00
ZMS-4836♦	20	48	36	1 5/16	23.0	77.00
<b>REPLACEMENT SHELF CLIPS</b>						
ZSC-1♦	—	—	—	—	0.1	.87

### Z-LINE SIDE AND BACK PANELS

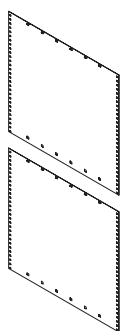

BACK PANEL

Back panels fit units with EUR and ZTP posts. Back consists of two pieces. Includes 10 attachment clips. Other sizes available; contact factory.

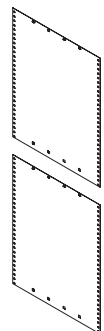

SIDE PANEL

Side panels fit starter units with EUR posts only. Side consists of two pieces. Includes 10 attachment clips. Other sizes available; contact factory.

CAT. NO.	W	D	H	WT.	PRICE
<b>SIDE PANELS</b>					
ZLEP-1284	—	12	84	11.5	64.00
ZLEP-1584	—	15	84	14.0	64.00
ZLEP-1884	—	18	84	16.6	72.00
ZLEP-2484	—	24	84	22.0	86.00
ZLEP-3084	—	30	84	27.0	99.00
<b>BACK PANELS</b>					
ZLBP-3684	36	—	84	35.0	126.00
ZLBP-4284	42	—	84	42.0	139.00
ZLBP-4884	48	—	84	48.0	152.00

### SHELF DIVIDER

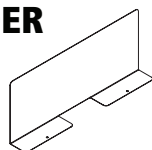

CAT. NO.	W	D	H	WT.	PRICE
DIV2410	—	24	10	4.4	16.50

Use on particleboard, front-to-back, to subdivide shelf into several storage areas.

### BOX RAILS

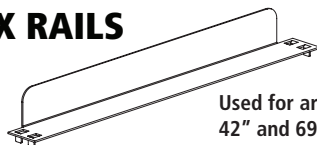

Used for archive box storage. Used with 42" and 69" LRA shelf supports only.

♦ QUICKSHIP COLOR: Sand

CAT. NO.	W	D	H	WT.	PRICE
ZBR-15♦	1 5/8	15	1 5/8	0.8	4.10
ZBR-30♦	1 5/8	30	1 5/8	1.6	6.60

### Z-LINE CASTER KIT

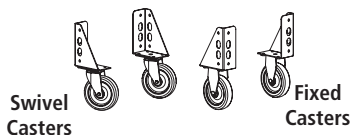

Load capacity for caster kit is 1,000 lbs. Casters should not be used with units over 96" tall, or on units less than 18" deep. Maximum unit size is 60" wide by 30" deep.

CAT. NO.	CASTERS	W	D	H	WT.	PRICE
ZLCK-1	2 Fixed, 2 Swivel	1 1/2	1 1/2	7/16	12.8	132.00
ZLCK-2	4 Swivel	3 7/16	2	7/16	13.0	135.00

### POST SPLICE ANGLE

Includes hardware. Used for splicing EUR, SUR and ZTP upright posts. When splicing ZTP uprights, two post splice angles are required.

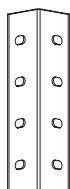

CAT. NO.	W	D	H	WT.	PRICE
PSA-2	1 9/16	1 9/16	6 1/2	1.1	6.70

# Z-LINE COMPONENTS

## Hang Rods, Protective Caps and Accessories

Look for the red diamond!

### HANG RODS

♦ QUICKSHIP COLORS: Sand and Medium Grey

CAT. NO.	LOAD CAP.	W	D	H	WT.	PRICE
<b>FOR LRA OR LRC SUPPORTS</b>						
<b>Channel-Shaped Hang Rods</b>						
PHR-36♦	150	36 1/4	1 5/16	1 1/16	2.9	8.70
PHR-48♦	150	48 1/4	1 5/16	1 1/16	3.8	11.10
<b>Round Hang Rods</b>						
OHR-36	150	36 1/4	1 1/4 Diameter		2.5	16.70
OHR-48	150	48 1/4	1 1/4 Diameter		3.3	18.80
<b>FOR DRS SUPPORTS</b>						
ZHR-36♦	150	36 3/16	7/8	1 1/16	2.3	7.60
ZHR-48♦	150	48 3/16	7/8	1 1/16	3.1	9.70

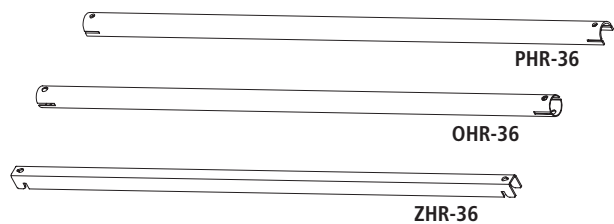

Used for hanging items left-to-right on a Z line unit.  
Attaches between two shelf supports.

### PROTECTIVE CAPS

♦ QUICKSHIP COLOR: Black

CAT. NO.	LOAD CAP.	W	D	H	WT.	PRICE
<b>SOFT TOP EDGE CAPS</b>						
EURPC♦	EUR Uprights	1 1/2	1 1/2	7/16	0.1	.88
ZTPPC♦	ZTP Uprights	3 7/16	2	7/16	0.1	1.30
SURPC♦	SUR Uprights	2 3/4	2 3/4	7/16	0.1	.85
<b>HARD NYLON FOOT CAPS</b>						
EURNF♦	EUR Uprights	1 1/2	1 1/2	3/4	0.1	.80
ZTPNF♦	ZTP Uprights	3 7/16	2	3/4	0.2	1.30
SURNF♦	SUR Uprights	2 3/4	2 3/4	3/4	0.2	1.10

Place top edge caps over top of uprights to protect from sharp edges.  
Place foot caps beneath uprights as a floor protector.

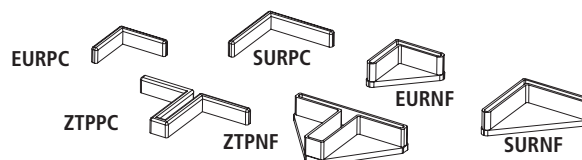

### AISLE TIES

♦ QUICKSHIP COLORS: Sand and Medium Grey

CAT. NO.	W	D	H	WT.	PRICE
<b>CROSS AISLE TIES</b>					
CAT-18♦	1 3/8	18	2 3/8	1.4	10.00
CAT-24	1 3/8	24	2 3/8	1.9	11.00
CAT-30	1 3/8	30	2 3/8	2.4	13.30
CAT-36♦	1 3/8	36	2 3/8	2.8	14.20
CAT-42	1 3/8	42	2 3/8	3.3	15.70
CAT-48	1 3/8	48	2 3/8	3.8	20.00
<b>ADJUSTABLE AISLE TIE</b>					
KCAT-1♦	3	*	1	6.0	26.00

\*Depth adjusts from 36" to 60"

Used to link units across an aisle for extra stability.  
Adjustable Aisle Tie links units across an aisle at adjustable distances.

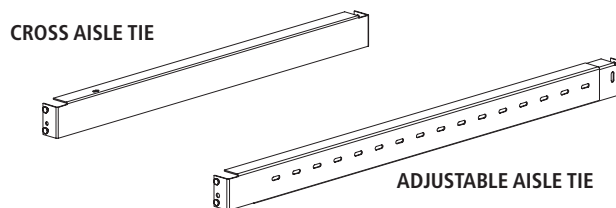

### WALL TIE

♦ QUICKSHIP COLORS: Sand and Medium Grey

CAT. NO.	W	D	H	WT.	PRICE
WT-9♦	9 1/4	1 3/8	2 3/8	0.7	4.90

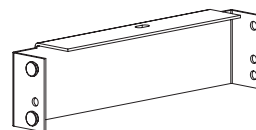

Used to secure a unit to a wall, with a 9" gap between the unit and the wall.

### TIE PLATE

♦ QUICKSHIP COLORS: Sand and Medium Grey

CAT. NO.	W	D	H	WT.	PRICE
TP-1♦	3	—	2 3/4	0.2	1.50



Used to secure two angle posts together front-to-back or side-by-side.

### ANCHOR PLATE

♦ QUICKSHIP COLORS: Sand and Medium Grey

CAT. NO.	W	D	H	WT.	PRICE
ZFA-1♦	1 3/8	1 1/2	2 3/8	0.2	2.70



Attaches to uprights to allow anchoring uprights to the floor.

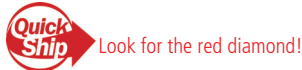

### RECORD ARCHIVE STORAGE RACKS

◆ QUICKSHIP COLORS: Sand and Medium Grey

UNIT SIZE			NO. OF OPENINGS	SHELF CAP.*	CUSTOMER SUPPLIES DECKING			WITH PARTICLEBOARD DECKING		
W	D	H			CAT NO.	WT.	PRICE	CAT NO.	WT.	PRICE
42	15	60	2	2,250	ZA421560-3◆	41.0	<b>131.00</b>	ZA421560-3D◆	73.0	<b>156.00</b>
42	15	84	3	2,250	ZA421584-4◆	55.0	<b>177.00</b>	ZA421584-4D◆	98.0	<b>210.00</b>
42	30	60	2	2,250	ZA423060-3◆	47.0	<b>149.00</b>	ZA423060-3D◆	113.0	<b>199.00</b>
42	30	84	3	2,250	ZA423084-4◆	64.0	<b>200.00</b>	ZA423084-4D◆	151.0	<b>267.00</b>
69	15	60	2	1,800	ZA691560-3◆	57.0	<b>176.00</b>	ZA691560-3D◆	111.0	<b>218.00</b>
69	15	84	3	1,800	ZA691584-4◆	76.0	<b>237.00</b>	ZA691584-4D◆	148.0	<b>293.00</b>
69	30	60	2	1,800	ZA693060-3◆	67.0	<b>203.00</b>	ZA693060-3D◆	175.0	<b>305.00</b>
69	30	84	3	1,800	ZA693084-4◆	90.0	<b>272.00</b>	ZA693084-4D◆	234.0	<b>408.00</b>

\*Load capacity figures are calculated in pounds per shelf level, evenly distributed. Total unit capacity, using four EUR up rights, not to exceed 8,000 lbs., based on 24" centers or less.

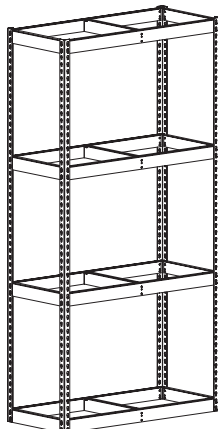

ZA421584-4

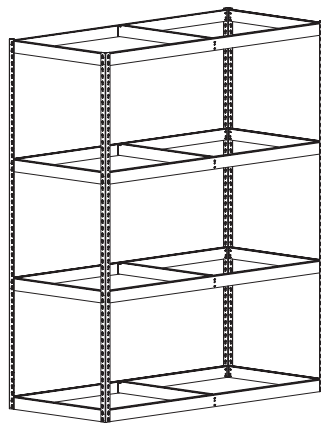

ZA693084-4

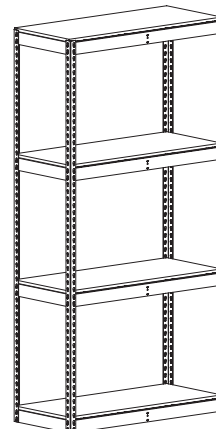

ZA421584-4D

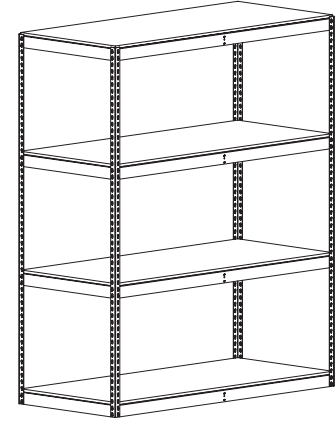

ZA693084-4D

### STEEL SHELVING UNITS

◆ QUICKSHIP COLOR: Medium Grey

UNIT SIZE			SHELF CAP.*	STARTER UNITS			ADDER UNITS			EXTRA SHELF LEVEL		
W	D	H		CAT NO.	WT.	PRICE	CAT NO.	WT.	PRICE	CAT NO.	WT.	PRICE
36	12	84	750	ZM7-3612S-5D◆	61.0	<b>203.00</b>	ZM7-3612A-5D◆	59.0	<b>199.00</b>	ZMS-3612◆	6.7	<b>23.00</b>
36	18	84	750	ZM7-3618S-5D◆	73.0	<b>233.00</b>	ZM7-3618A-5D◆	70.0	<b>227.00</b>	ZMS-3618◆	8.8	<b>28.00</b>
36	24	84	700	ZM7-3624S-5D◆	85.0	<b>265.00</b>	ZM7-3624A-5D◆	82.0	<b>258.00</b>	ZMS-3624◆	10.9	<b>34.00</b>
36	36	84	600	ZM7-3636S-5D◆	122.0	<b>423.00</b>	ZM7-3636A-5D◆	118.0	<b>412.00</b>	ZMS-3636◆	17.9	<b>64.00</b>
42	12	84	600	ZM7-4212S-5D◆	68.0	<b>239.00</b>	ZM7-4212A-5D	66.0	<b>235.00</b>	ZMS-4212◆	7.7	<b>29.00</b>
42	18	84	600	ZM7-4218S-5D◆	81.0	<b>277.00</b>	ZM7-4218A-5D◆	78.0	<b>271.00</b>	ZMS-4218◆	10.1	<b>36.00</b>
42	24	84	550	ZM7-4224S-5D◆	95.0	<b>315.00</b>	ZM7-4224A-5D◆	91.0	<b>308.00</b>	ZMS-4224◆	12.5	<b>43.00</b>
42	36	84	550	ZM7-4236S-5D	137.0	<b>458.00</b>	ZM7-4236A-5D	132.0	<b>447.00</b>	ZMS-4236	21.0	<b>70.00</b>
48	12	84	500	ZM7-4812S-5D◆	74.0	<b>242.00</b>	ZM7-4812A-5D◆	72.0	<b>237.00</b>	ZMS-4812◆	8.7	<b>29.00</b>
48	18	84	500	ZM7-4818S-5D◆	89.0	<b>280.00</b>	ZM7-4818A-5D◆	86.0	<b>274.00</b>	ZMS-4818◆	11.4	<b>36.00</b>
48	24	84	450	ZM7-4824S-5D◆	104.0	<b>318.00</b>	ZM7-4824A-5D◆	100.0	<b>311.00</b>	ZMS-4824◆	14.1	<b>43.00</b>
48	36	84	450	ZM7-4836S-5D◆	150.0	<b>496.00</b>	ZM7-4836A-5D◆	146.0	<b>484.00</b>	ZMS-4836◆	23.0	<b>77.00</b>

\*Load capacity figures are calculated in pounds per shelf level, evenly distributed. Total unit capacity, using four EUR uprights, not to exceed 8,000 lbs., based on 24" centers or less.

Starter and adder units include 5 shelf levels.  
Starter units use 4 EUR uprights; adder units use 2 ZTP uprights.  
Each unit is stabilized by VDRS shelf supports at both top and bottom.  
Intermediate shelves are attached by 4 ZSC-1 shelf clips.

No sway braces required, allowing access from all 4 sides.

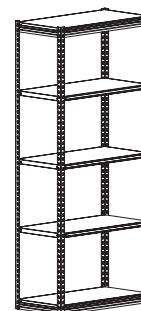

STARTER UNIT

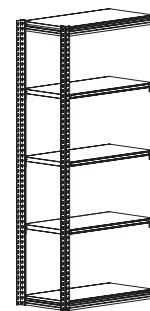

ADDER UNIT



# Z-LINE SHELVING

## Sloped Shelving & Die Rack Units

Look for the red diamond! 

♦ QUICKSHIP COLOR: Medium Grey

CAT. NO.	SHELF CAP.*	W	D	H	WT.	PRICE
<b>STARTER UNITS</b>						
ZT7-3618S-5♦	450	36	18	84	137.0	<b>455.00</b>
ZT7-3624S-5♦	450	36	24	84	160.0	<b>511.00</b>
ZT7-4818S-5♦	350	48	18	84	187.0	<b>590.00</b>
ZT7-4824S-5♦	350	48	24	84	217.0	<b>658.00</b>
<b>ADDER UNITS</b>						
ZT7-3618A-5♦	450	36	18	84	136.0	<b>457.00</b>
ZT7-3624A-5♦	450	36	24	84	159.0	<b>513.00</b>
ZT7-4818A-5♦	350	48	18	84	186.0	<b>592.00</b>
ZT7-4824A-5♦	350	48	24	84	217.0	<b>660.00</b>
<b>EXTRA SHELF LEVELS</b>						
ZSSS-3618♦	450	36	18	—	17.9	<b>68.00</b>
ZSSS-3624♦	450	36	24	—	23.0	<b>83.00</b>
ZSSS-4818♦	350	48	18	—	27.0	<b>92.00</b>
ZSSS-4824♦	350	48	24	—	33.0	<b>105.00</b>

\*Load capacities are per shelf, evenly distributed and based on shelves spaced on 24" centers. Weight not to exceed a total of 1,500 lbs. per unit.

Includes 5 sloped shelves and one top shelf.

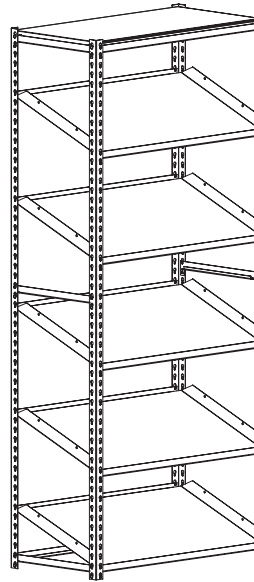

### SLOPED SHELF UNITS (FLAT SLOPE STYLE)

♦ QUICKSHIP COLOR: Medium Grey

CAT. NO.	SHELF CAP.*	SUPPORTS PER LEVEL	W	D	H	WT.	PRICE
<b>DIE RACK UNITS</b>							
RXHS-361872♦	4,000	1	36	18	72	147.0	<b>510.00</b>
RXHS-362472♦	4,000	1	36	24	72	202.0	<b>574.00</b>
RXHS-481872♦	4,000	1	48	18	72	181.0	<b>611.00</b>
RXHS-482472♦	4,000	1	48	24	72	214.0	<b>683.00</b>
RXHS-602472♦	3,250	1	60	24	72	255.0	<b>813.00</b>
RXHS-722472♦	2,750	2	72	24	72	305.0	<b>980.00</b>
RXHS-361884♦	4,000	1	36	18	84	151.0	<b>522.00</b>
RXHS-362484♦	4,000	1	36	24	84	206.0	<b>586.00</b>
RXHS-481884♦	4,000	1	48	18	84	185.0	<b>623.00</b>
RXHS-482484♦	4,000	1	48	24	84	218.0	<b>695.00</b>
RXHS-602484♦	3,250	1	60	24	84	259.0	<b>825.00</b>
RXHS-722484♦	2,750	2	72	24	84	309.0	<b>992.00</b>
RXHS-723684♦	2,750	2	72	36	84	419.0	<b>1,344.00</b>
RXHS-962484♦	2,600	3	96	24	84	413.0	<b>1,394.00</b>
RXHS-963684♦	2,600	3	96	36	84	560.0	<b>1,760.00</b>
RXHS-361896♦	4,000	1	36	18	96	155.0	<b>534.00</b>
RXHS-362496♦	4,000	1	36	24	96	210.0	<b>598.00</b>
RXHS-481896♦	4,000	1	48	18	96	189.0	<b>635.00</b>
RXHS-482496♦	4,000	1	48	24	96	222.0	<b>707.00</b>
RXHS-602496♦	3,250	1	60	24	96	263.0	<b>837.00</b>
RXHS-722496♦	2,750	2	72	24	96	313.0	<b>1,004.00</b>
RXHS-723696♦	2,750	2	72	36	96	424.0	<b>1,356.00</b>
RXHS-962496♦	2,600	3	96	24	96	417.0	<b>1,407.00</b>
RXHS-963696♦	2,600	3	96	36	96	565.0	<b>1,773.00</b>
<b>EXTRA SHELF LEVELS</b>							
RXHS-3618♦	4,000	1	36	18	2 11/16	25.0	<b>89.00</b>
RXHS-3624♦	4,000	1	36	24	2 11/16	32.0	<b>99.00</b>
RXHS-4818♦	4,000	1	48	18	2 11/16	32.0	<b>107.00</b>
RXHS-4824♦	4,000	1	48	24	2 11/16	40.0	<b>121.00</b>
RXHS-6024♦	3,250	1	60	24	2 11/16	47.0	<b>149.00</b>
RXHS-7224♦	2,750	2	72	24	2 11/16	57.0	<b>179.00</b>
RXHS-7236♦	2,750	2	72	36	2 11/16	79.0	<b>254.00</b>
RXHS-9624♦	2,600	3	96	24	2 11/16	78.0	<b>266.00</b>
RXHS-9636♦	2,600	3	96	36	2 11/16	108.0	<b>339.00</b>

\*Load capacities are per shelf, evenly distributed and based on shelves spaced on 24" centers. Weight not to exceed a total of 13,000 lbs. per unit.

Die rack units include 5 shelf levels.

### HEAVY-DUTY REINFORCED SHELVING (DIE RACK UNIT)

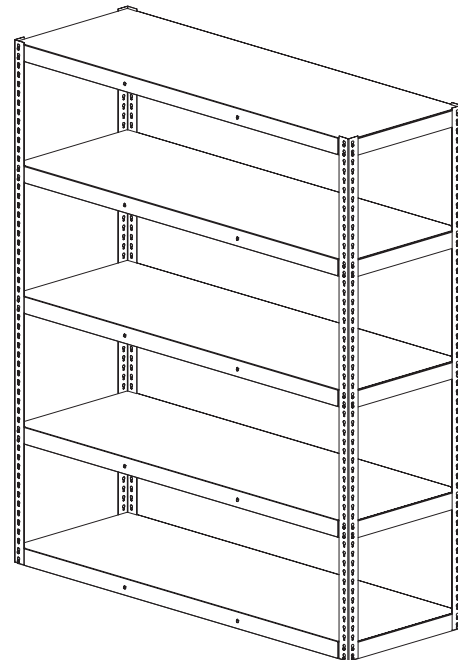

Available in Medium Grey only.  
Other heights are available; call factory for pricing.



Look for the red diamond!

### 4 SHELVES, 3 OPENINGS — With Particleboard Decking

♦ QUICKSHIP COLORS: Sand and Medium Grey

UNIT SIZE			SHELF CAP.*	STARTER UNITS			ADDER UNITS			EXTRA SHELF LEVEL		
W	D	H		CAT NO.	WT.	PRICE	CAT NO.	WT.	PRICE	CAT NO.	WT.	PRICE
36	12	84	600	ZA7-3612S-4♦	65.0	138.00	ZA7-3612A-4♦	63.0	132.00	ZAES-3612D♦	10.9	16.40
36	18	84	600	ZA7-3618S-4♦	83.0	155.00	ZA7-3618A-4♦	80.0	146.00	ZAES-3618D♦	14.7	19.40
36	24	84	600	ZA7-3624S-4♦	99.0	168.00	ZA7-3624A-4♦	95.0	159.00	ZAES-3624D♦	18.4	22.00
36	36	84	600	ZA7-3636S-4♦	136.0	212.00	ZA7-3636A-4♦	135.0	213.00	ZAES-3636D♦	29.0	41.00
42	12	84	550	ZA7-4212S-4♦	73.0	150.00	ZA7-4212A-4♦	71.0	144.00	ZAES-4212D♦	12.8	19.40
42	18	84	550	ZA7-4218S-4♦	93.0	168.00	ZA7-4218A-4♦	89.0	159.00	ZAES-4218D♦	17.1	23.00
42	24	84	550	ZA7-4224S-4♦	111.0	183.00	ZA7-4224A-4♦	107.0	173.00	ZAES-4224D♦	22.0	26.00
42	36	84	550	ZA7-4236S-4♦	154.0	225.00	ZA7-4236A-4♦	153.0	227.00	ZAES-4236D♦	34.0	45.00
48	12	84	500	ZA7-4812S-4♦	80.0	158.00	ZA7-4812A-4♦	78.0	151.00	ZAES-4812D♦	14.6	21.00
48	18	84	500	ZA7-4818S-4♦	103.0	178.00	ZA7-4818A-4♦	99.0	169.00	ZAES-4818D♦	19.6	25.00
48	24	84	500	ZA7-4824S-4♦	124.0	190.00	ZA7-4824A-4♦	120.0	181.00	ZAES-4824D♦	25.0	28.00
48	36	84	500	ZA7-4836S-4♦	175.0	239.00	ZA7-4836A-4♦	174.0	240.00	ZAES-4836D♦	38.0	48.00

### 4 SHELVES, 3 OPENINGS — Without Decking

♦ QUICKSHIP COLORS: Sand and Medium Grey

UNIT SIZE			SHELF CAP.*	STARTER UNITS			ADDER UNITS			EXTRA SHELF LEVEL		
W	D	H		CAT NO.	WT.	PRICE	CAT NO.	WT.	PRICE	CAT NO.	WT.	PRICE
36	12	84	600	ZA7-3612S-4♦	35.0	114.00	ZA7-3612A-4♦	33.0	108.00	ZAES-3612♦	3.4	10.40
36	18	84	600	ZA7-3618S-4♦	38.0	119.00	ZA7-3618A-4♦	34.0	110.00	ZAES-3618♦	3.4	10.40
36	24	84	600	ZA7-3624S-4♦	39.0	120.00	ZA7-3624A-4♦	35.0	111.00	ZAES-3624♦	3.4	10.40
36	36	84	600	ZA7-3636S-4♦	46.0	140.00	ZA7-3636A-4♦	45.0	141.00	ZAES-3636♦	6.8	23.00
42	12	84	550	ZA7-4212S-4♦	38.0	120.00	ZA7-4212A-4♦	36.0	113.00	ZAES-4212♦	4.0	11.80
42	18	84	550	ZA7-4218S-4♦	40.0	125.00	ZA7-4218A-4♦	37.0	116.00	ZAES-4218♦	4.0	11.80
42	24	84	550	ZA7-4224S-4♦	41.0	126.00	ZA7-4224A-4♦	37.0	116.00	ZAES-4224♦	4.0	11.80
42	36	84	550	ZA7-4236S-4♦	48.0	145.00	ZA7-4236A-4♦	48.0	147.00	ZAES-4236♦	7.6	25.00
48	12	84	500	ZA7-4812S-4♦	40.0	125.00	ZA7-4812A-4♦	38.0	119.00	ZAES-4812♦	4.6	13.20
48	18	84	500	ZA7-4818S-4♦	43.0	130.00	ZA7-4818A-4♦	39.0	121.00	ZAES-4818♦	4.6	13.20
48	24	84	500	ZA7-4824S-4♦	44.0	131.00	ZA7-4824A-4♦	40.0	122.00	ZAES-4824♦	4.6	13.20
48	36	84	500	ZA7-4836S-4♦	51.0	151.00	ZA7-4836A-4♦	50.0	152.00	ZAES-4836♦	8.0	24.00

\*Load capacity in pounds per shelf level, evenly distributed. Total unit capacity, using four uprights, not to exceed 8,000 lbs., based on 24" centers or less.

Starter units use four EUR uprights and six DRS end supports; adder units use two ZTP uprights and three DRS end supports. Shelves are supported, on front and rear only, by low profile shelf supports (DRS-dd). 36" deep shelves are supported on all four sides.

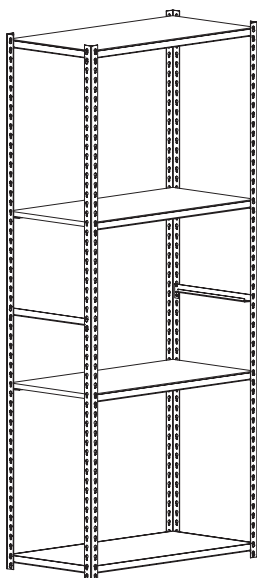

STARTER UNIT WITH DECKING

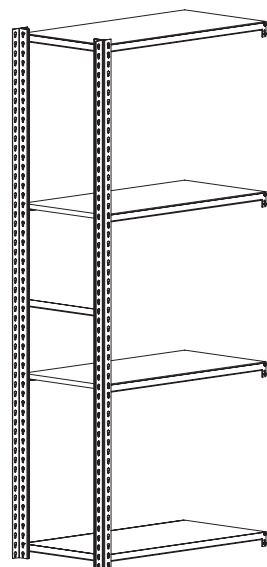

ADD-ON UNIT WITH DECKING

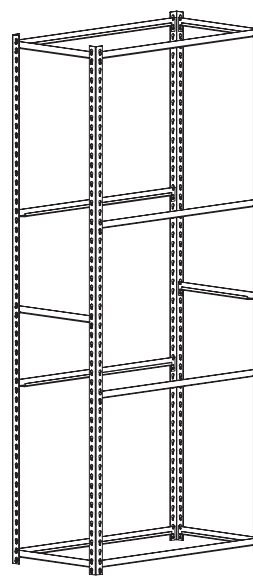

STARTER UNIT WITHOUT DECKING

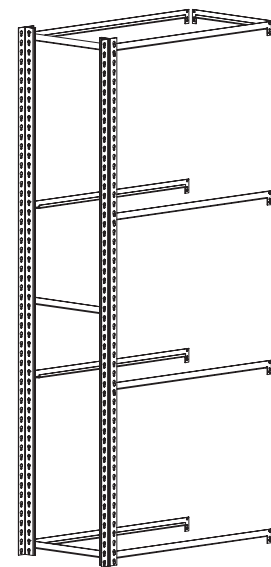

ADD-ON UNIT WITHOUT DECKING

# Z-LINE SHELVING

## Long Span Shelving Units

Look for the red diamond! 

### HEAVY DUTY LONG SPAN SHELVING — With Particleboard Decking

◆ QUICKSHIP COLOR: Sand and Medium Grey

CAT. NO.	SHELF CAP.*	SUPPORTS PER LEVEL	W	D	H	WT.	PRICE	EXTRA LEVELS		
								CAT. NO.	WT.	PRICE
ZL7-4824-3D◆	2,250	1	48	24	84	125.0	243.00	ZLES-4824D◆	33.0	55.00
ZL7-4830-3D◆	2,250	1	48	30	84	144.0	271.00	ZLES-4830D◆	39.0	64.00
ZL7-4836-3D◆	2,250	1	48	36	84	166.0	289.00	ZLES-4836D◆	47.0	70.00
ZL7-4848-3D◆	2,250	1	48	48	84	202.0	340.00	ZLES-4848D◆	59.0	87.00
ZL7-6024-3D◆	2,000	1	60	24	84	146.0	277.00	ZLES-6024D◆	40.0	66.00
ZL7-6030-3D◆	2,000	1	60	30	84	169.0	301.00	ZLES-6030D◆	48.0	74.00
ZL7-6036-3D◆	2,000	1	60	36	84	192.0	330.00	ZLES-6036D◆	55.0	84.00
ZL7-6048-3D◆	2,000	1	60	48	84	238.0	375.00	ZLES-6048D◆	71.0	99.00
ZL7-7224-3D◆	1,750	2	72	24	84	173.0	337.00	ZLES-7224D◆	49.0	86.00
ZL7-7230-3D◆	1,750	2	72	30	84	201.0	359.00	ZLES-7230D◆	58.0	93.00
ZL7-7236-3D◆	1,750	2	72	36	84	229.0	397.00	ZLES-7236D◆	68.0	106.00
ZL7-7248-3D◆	1,750	2	72	48	84	285.0	458.00	ZLES-7248D◆	86.0	126.00
ZL7-9624-3D◆	1,250	3	96	24	84	220.0	408.00	ZLES-9624D◆	65.0	110.00
ZL7-9630-3D◆	1,250	3	96	30	84	256.0	444.00	ZLES-9630D◆	77.0	121.00
ZL7-9636-3D◆	1,250	3	96	36	84	293.0	493.00	ZLES-9636D◆	89.0	138.00
ZL7-9648-3D◆	1,250	3	96	48	84	367.0	573.00	ZLES-9648D◆	114.0	164.00

### HEAVY DUTY LONG SPAN SHELVING — Without Decking

◆ QUICKSHIP COLOR: Sand and Medium Grey

CAT. NO.	SHELF CAP.*	SUPPORTS PER LEVEL	W	D	H	WT.	PRICE	EXTRA LEVELS		
								CAT. NO.	WT.	PRICE
ZL7-4824-3◆	2,250	1	48	24	84	65.0	199.00	ZLES-4824◆	13.1	40.00
ZL7-4830-3◆	2,250	1	48	30	84	69.0	211.00	ZLES-4830◆	14.4	44.00
ZL7-4836-3◆	2,250	1	48	36	84	73.0	223.00	ZLES-4836◆	15.8	48.00
ZL7-4848-3◆	2,250	1	48	48	84	82.0	244.00	ZLES-4848◆	18.6	55.00
ZL7-6024-3◆	2,000	1	60	24	84	71.0	217.00	ZLES-6024◆	15.1	46.00
ZL7-6030-3◆	2,000	1	60	30	84	75.0	229.00	ZLES-6030◆	16.4	50.00
ZL7-6036-3◆	2,000	1	60	36	84	79.0	240.00	ZLES-6036◆	17.8	54.00
ZL7-6048-3◆	2,000	1	60	48	84	88.0	261.00	ZLES-6048◆	21.0	61.00
ZL7-7224-3◆	1,750	2	72	24	84	83.0	259.00	ZLES-7224◆	19.0	60.00
ZL7-7230-3◆	1,750	2	72	30	84	88.0	275.00	ZLES-7230◆	21.0	65.00
ZL7-7236-3◆	1,750	2	72	36	84	94.0	289.00	ZLES-7236◆	23.0	70.00
ZL7-7248-3◆	1,750	2	72	48	84	105.0	317.00	ZLES-7248◆	26.0	79.00
ZL7-9624-3◆	1,250	3	96	24	84	100.0	312.00	ZLES-9624◆	25.0	78.00
ZL7-9630-3◆	1,250	3	96	30	84	106.0	333.00	ZLES-9630◆	27.0	84.00
ZL7-9636-3◆	1,250	3	96	36	84	113.0	349.00	ZLES-9636◆	29.0	90.00
ZL7-9648-3◆	1,250	3	96	48	84	127.0	384.00	ZLES-9648◆	34.0	101.00

\*Load capacity in pounds per shelf level, evenly distributed. Total unit capacity not to exceed 13,000 lbs. per unit (3,250 lbs. per post) based on 24" centers or less.

Heavy duty long span units include 3 shelf levels.

Units use SUR uprights.

Shelves supported on all four sides with heavy duty profile shelf supports (LRA-xx).

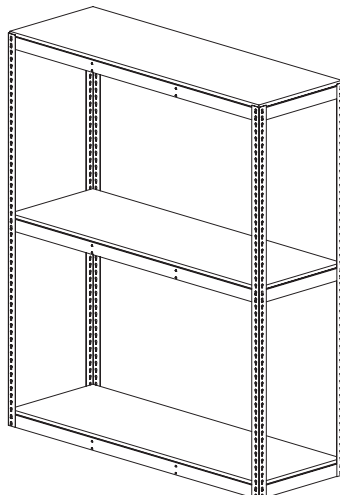

UNIT WITH DECKING

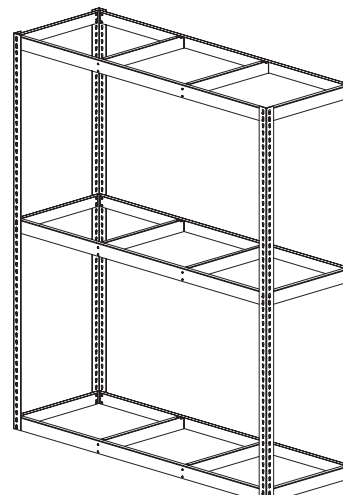

UNIT WITHOUT DECKING

# LOGIC SHELVING

## Wire Shelving, Mobile Carts, Casters, Bumper

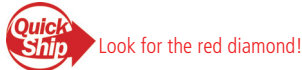

**NOTE: Logic Shelving available in Pearl Grey, Arctic White and Black only.**

### WIRE SHELVING UNITS



**STARTER UNIT**  
**ADDER UNIT**  
Starter and adder units include 4 shelf levels.

◆ QUICKSHIP COLOR: Arctic White and Pearl Grey

W	D	H	CAT NO.	WT.	PRICE	CAT NO.	WT.	PRICE
<b>STARTER UNITS</b>								
36	18	75	E-361875-4◆	66.0	<b>392.00</b>	E-361875-4A◆	54.0	<b>345.00</b>
36	24	75	E-362475-4◆	74.0	<b>432.00</b>	E-362475-4A◆	62.0	<b>385.00</b>
42	18	75	E-421875-4	71.0	<b>472.00</b>	E-421875-4A	59.0	<b>425.00</b>
42	24	75	E-422475-4	81.0	<b>500.00</b>	E-422475-4A	69.0	<b>453.00</b>
48	18	75	E-481875-4◆	77.0	<b>440.00</b>	E-481875-4A◆	65.0	<b>393.00</b>
48	24	75	E-482475-4	88.0	<b>480.00</b>	E-482475-4A	76.0	<b>433.00</b>
60	18	75	E-601875-4	109.0	<b>516.00</b>	E-601875-4A	97.0	<b>469.00</b>
60	24	75	E-602475-4◆	125.0	<b>556.00</b>	E-602475-4A◆	113.0	<b>509.00</b>
72	18	75	E-721875-4	129.0	<b>612.00</b>	E-721875-4A	117.0	<b>565.00</b>
72	24	75	E-722475-4◆	145.0	<b>652.00</b>	E-722475-4A◆	133.0	<b>605.00</b>

### WIRE SHELF CARTS



4 swivel casters included.  
Casters have a 300 lb.  
load capacity.

CAT. NO.	W	D	H	WT.	PRICE
<b>4 SHELVES, 57" POST HEIGHT</b>					
ME-361862-4	36	18	62	70.0	<b>467.00</b>
ME-362462-4	36	24	62	79.0	<b>507.00</b>
ME-421862-4	42	18	62	76.0	<b>547.00</b>
ME-422462-4	42	24	62	86.0	<b>575.00</b>
ME-481862-4	48	18	62	82.0	<b>515.00</b>
ME-482462-4	48	24	62	92.0	<b>555.00</b>
ME-601862-4	60	18	62	114.0	<b>591.00</b>
ME-602462-4	60	24	62	130.0	<b>631.00</b>
<b>4 SHELVES, 62" POST HEIGHT</b>					
ME-361868-4	36	18	68	72.0	<b>475.00</b>
ME-362468-4	36	24	68	80.0	<b>515.00</b>
ME-421868-4	42	18	68	77.0	<b>555.00</b>
ME-422468-4	42	24	68	87.0	<b>583.00</b>
ME-481868-4	48	18	68	83.0	<b>523.00</b>
ME-482468-4	48	24	68	94.0	<b>563.00</b>
ME-601868-4	60	18	68	115.0	<b>599.00</b>
ME-602468-4	60	24	68	131.0	<b>639.00</b>

### WIRE SHELF HAND CARTS



4 swivel casters included.  
Casters have a 300 lb.  
load capacity.

◆ QUICKSHIP COLOR: Arctic White and Pearl Grey

CAT. NO.	W	D	H	WT.	PRICE
<b>2 SHELVES, 42" POST HEIGHT</b>					
HE-361835-2◆	36	18	42	44.0	<b>312.00</b>
HE-362435-2◆	36	24	42	50.0	<b>334.00</b>
HE-421835-2	42	18	42	46.0	<b>352.00</b>
HE-422435-2	42	24	42	53.0	<b>368.00</b>
HE-481835-2◆	48	18	42	49.0	<b>336.00</b>
HE-482435-2	48	24	42	57.0	<b>358.00</b>
HE-602435-2◆	60	24	42	77.0	<b>420.00</b>
<b>3 SHELVES, 42" POST HEIGHT</b>					
HE-361835-3◆	36	18	42	55.0	<b>383.00</b>
HE-362435-3◆	36	24	42	63.0	<b>415.00</b>
HE-421835-3	42	18	42	58.0	<b>441.00</b>
HE-422435-3	42	24	42	68.0	<b>466.00</b>
HE-481835-3◆	48	18	42	63.0	<b>419.00</b>
HE-482435-3	48	24	42	73.0	<b>451.00</b>
HE-602435-3◆	60	24	42	101.0	<b>508.00</b>

### CASTERS

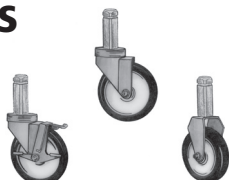

Please Note: Casters must be used with No-Glide Posts (available on page 13)

DESCRIPTION	WHEEL DIA.	CASTER LOAD	CAT NO.	WT.	PRICE
Poly Swivel	5	300	LC-1	2.0	<b>14.70</b>
Poly Swivel w/ Brake	5	300	LC-2	2.5	<b>17.30</b>
Poly Fixed	5	300	LC-3	1.5	<b>12.30</b>

### BUMPER

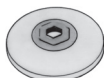

Use in conjunction with casters.

DESCRIPTION	DIA.	CAT. NO.	WT.	PRICE
Rubber Bumper	5	RD-1	0.5	<b>6.00</b>

# LOGIC SHELVING Accessories

**NOTE:** Logic Shelving available in Pearl Grey, Arctic White and Black only.

Look for the red diamond!

## LOGIC SHELVES

♦ QUICKSHIP COLOR: Arctic White and Pearl Grey

W	D	CAT NO.	WT.	PRICE	CAT NO.	WT.	PRICE	CAT NO.	WT.	PRICE	
<b>STARTER SHELVES</b>			<b>ADD-ON SHELVES</b>			<b>90° ADD-ON SHELVES</b>					
36	18	LE-3618P♦	10.9	<b>71.00</b>	LE-3618A♦	10.6	<b>73.00</b>	LE-3618N♦	10.7	<b>74.00</b>	
36	24	LE-3624P♦	13.0	<b>81.00</b>	LE-3624A♦	12.7	<b>83.00</b>	LE-3624N♦	12.8	<b>84.00</b>	
42	18	LE-4218P♦	12.2	<b>91.00</b>	LE-4218A♦	11.9	<b>93.00</b>	LE-4218N♦	12.0	<b>94.00</b>	
42	24	LE-4224P♦	14.7	<b>98.00</b>	LE-4224A♦	14.4	<b>100.00</b>	LE-4224N♦	14.5	<b>101.00</b>	
48	18	LE-4818P♦	13.7	<b>83.00</b>	LE-4818A♦	13.4	<b>85.00</b>	LE-4818N♦	13.5	<b>86.00</b>	
48	24	LE-4824P♦	16.4	<b>93.00</b>	LE-4824A♦	16.1	<b>95.00</b>	LE-4824N♦	16.2	<b>96.00</b>	
60	18	LE-6018P♦	22.0	<b>102.00</b>	LE-6018A♦	21.0	<b>104.00</b>	LE-6018N♦	22.0	<b>105.00</b>	
60	24	LE-6024P♦	26.0	<b>112.00</b>	LE-6024A♦	25.0	<b>114.00</b>	LE-6024N♦	26.0	<b>115.00</b>	
72	18	LE-7218P♦	27.0	<b>126.00</b>	LE-7218A♦	26.0	<b>128.00</b>	LE-7218N♦	27.0	<b>129.00</b>	
72	24	LE-7224P♦	31.0	<b>136.00</b>	LE-7224A♦	30.0	<b>138.00</b>	LE-7224N♦	31.0	<b>142.00</b>	

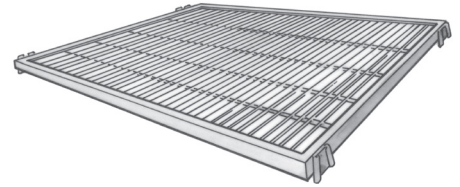

## LOGIC CLIPS

♦ QUICKSHIP COLOR: Arctic White and Pearl Grey

CAT. NO.	DESCRIPTION	W	D	H	WT.	PRICE
PCE♦	POST CLIP	—	—	—	0.2	<b>0.49</b>
ACE♦	ADD-ON CLIP	—	—	—	0.2	<b>1.90</b>
NACE	90° ANGLE CLIP	—	—	—	0.1	<b>2.00</b>

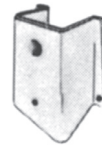

PCE

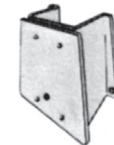

ACE



NACE

## LOGIC POSTS

♦ QUICKSHIP COLOR: Arctic White and Pearl Grey

CAT. NO.	DESCRIPTION	W	D	H	WT.	PRICE
<b>STANDARD POST</b>						
PE-63	—	—	63	4.8	<b>27.00</b>	
PE-75♦	—	—	75	5.5	<b>27.00</b>	
PE-87	—	—	87	6.5	<b>32.00</b>	
<b>NO-GLIDE POST (FOR USE WITH CASTERS)</b>						
PE-63NG	—	—	63	4.6	<b>27.00</b>	
PE-75NG	—	—	75	5.3	<b>27.00</b>	
PE-87NG	—	—	87	6.3	<b>32.00</b>	

Special length posts priced as next higher length plus a cutting charge of \$2.00 (list) per post.



## MISCELLANEOUS ACCESSORIES

CAT. NO.	W	D	H	WT.	PRICE
<b>POST EXTENDER</b>					
PEXE	—	—	—	0.5	<b>9.70</b>
<b>BACK TO BACK TIES</b>					
BTBE	—	—	—	0.5	<b>7.60</b>
<b>WALL TIES</b>					
WTBE	—	—	—	0.5	<b>2.60</b>
<b>LOGIC FOOT PLATE</b>					
LFP	—	—	—	0.2	<b>7.00</b>
<b>LOGIC FOOT CAP (PLASTIC)</b>					
LFC-1	—	—	—	0.1	<b>1.10</b>
<b>LOGIC POST GLIDE</b>					
LPG-1	—	—	—	0.2	<b>10.60</b>
<b>SINGLE SHELF WALL BRACKET</b>					
WBSE-18	—	18	—	10.7	<b>233.00</b>
WBSE-24	—	24	—	11.7	<b>235.00</b>
<b>SINGLE SHELF CENTER BRACKET ADD-ON</b>					
CBASE-18	—	18	—	10.0	<b>119.00</b>
CBASE-24	—	24	—	10.0	<b>126.00</b>
<b>DOUBLE SHELF WALL BRACKET</b>					
WBDE-18	—	18	—	16.8	<b>313.00</b>
WBDE-24	—	24	—	17.3	<b>316.00</b>
<b>DOUBLE SHELF CENTER BRACKET ADD-ON</b>					
CBADE-18	—	18	—	16.1	<b>166.00</b>
CBADE-24	—	24	—	16.1	<b>177.00</b>



PEXE - Use to splice posts

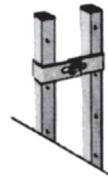

BTBE - Increases stability in adjacent shelving units

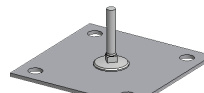
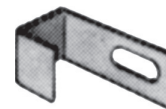

LFP



LFC-1



LPG-1

Mounting hardware not included.

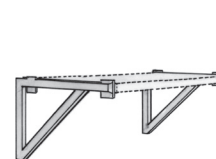

WBSE-18

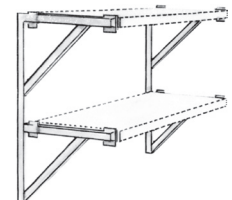

WBDE-18



Look for the red diamond!

# Q-LINE SHELVING

## Open Style Units, Hinged Door Units

### OPEN STYLE UNITS



Starter Unit



Adder Unit

◆ QUICKSHIP COLOR: Medium Grey

UNIT SIZE			SHELF CAP.*	STARTER UNITS			ADDER UNITS		
W	D	H		CAT NO.	WT.	PRICE	CAT NO.	WT.	PRICE
<b>5 SHELVES</b>									
36	12	87	750	Q05-3612S◆	63.0	<b>191.00</b>	Q05-3612A◆	60.0	<b>183.00</b>
36	18	87	750	Q05-3618S◆	73.0	<b>217.00</b>	Q05-3618A◆	71.0	<b>209.00</b>
36	24	87	700	Q05-3624S◆	84.0	<b>247.00</b>	Q05-3624A◆	81.0	<b>239.00</b>
48	12	87	500	Q05-4812S◆	73.0	<b>222.00</b>	Q05-4812A◆	71.0	<b>214.00</b>
48	18	87	500	Q05-4818S◆	87.0	<b>257.00</b>	Q05-4818A◆	84.0	<b>249.00</b>
48	24	87	450	Q05-4824S◆	100.0	<b>292.00</b>	Q05-4824A◆	98.0	<b>284.00</b>
<b>6 SHELVES</b>									
36	12	87	750	Q06-3612S◆	69.0	<b>213.00</b>	Q06-3612A◆	67.0	<b>205.00</b>
36	18	87	750	Q06-3618S◆	82.0	<b>244.00</b>	Q06-3618A◆	80.0	<b>236.00</b>
36	24	87	700	Q06-3624S◆	95.0	<b>280.00</b>	Q06-3624A◆	92.0	<b>272.00</b>
48	12	87	500	Q06-4812S◆	82.0	<b>250.00</b>	Q06-4812A◆	80.0	<b>242.00</b>
48	18	87	500	Q06-4818S◆	98.0	<b>292.00</b>	Q06-4818A◆	96.0	<b>284.00</b>
48	24	87	450	Q06-4824S◆	114.0	<b>334.00</b>	Q06-4824A◆	112.0	<b>326.00</b>
<b>8 SHELVES</b>									
36	12	87	750	Q08-3612S◆	83.0	<b>256.00</b>	Q08-3612A◆	80.0	<b>248.00</b>
36	18	87	750	Q08-3618S◆	100.0	<b>298.00</b>	Q08-3618A◆	97.0	<b>290.00</b>
36	24	87	700	Q08-3624S◆	116.0	<b>346.00</b>	Q08-3624A◆	114.0	<b>338.00</b>
48	12	87	500	Q08-4812S◆	99.0	<b>306.00</b>	Q08-4812A◆	97.0	<b>298.00</b>
48	18	87	500	Q08-4818S◆	121.0	<b>362.00</b>	Q08-4818A◆	119.0	<b>354.00</b>
48	24	87	450	Q08-4824S◆	143.0	<b>418.00</b>	Q08-4824A◆	140.0	<b>410.00</b>

All posts are Offset Angle Posts (OAP-87).  
All shelves are 22 gauge. (20 gauge units also available; call factory for pricing.)

### HINGED DOORS UNITS, HINGED DOOR & FRAME



◆ QUICKSHIP COLOR: Medium Grey

CAT. NO.	W	D	H	WT.	PRICE
<b>HINGED DOOR UNITS (With 7 Openings)</b>					
HDS-8712RH◆	36	12 §	87	172.0	<b>669.00</b>
HDS-8718RH◆	36	18 §	87	197.0	<b>736.00</b>
HDS-8724RH◆	36	24 §	87	221.0	<b>802.00</b>
<b>HINGED DOORS AND FRAMES</b>					
HD-3638RH◆	36	1 1/4*	38	28.0	<b>235.00</b>
HD-3687RH◆	36	1 1/4*	87	63.0	<b>326.00</b>

§ Depth does not include 1 1/4" depth of door frame or 1/2" depth of handle.  
\* Depth does not include 1/2" depth of handle.

Hinged doors come standard with one recessed handle.

# Q-LINE SHELVING

## Closed Style Units, Ledge Unit

Look for the red diamond!

### CLOSED STYLE UNITS

◆ QUICKSHIP COLOR: Medium Grey

UNIT SIZE			SHELF CAP.*	STARTER UNITS			ADDER UNITS		
W	D	H		CAT NO.	WT.	PRICE	CAT NO.	WT.	PRICE
<b>5 SHELVES</b>									
36	12	87	750	QC5-3612S◆	89.0	<b>278.00</b>	QC5-3612A◆	83.0	<b>258.00</b>
36	18	87	750	QC5-3618S◆	107.0	<b>330.00</b>	QC5-3618A◆	97.0	<b>297.00</b>
36	24	87	700	QC5-3624S◆	125.0	<b>378.00</b>	QC5-3624A◆	111.0	<b>336.00</b>
48	12	87	500	QC5-4812S◆	108.0	<b>331.00</b>	QC5-4812A◆	102.0	<b>311.00</b>
48	18	87	500	QC5-4818S◆	129.0	<b>392.00</b>	QC5-4818A◆	119.0	<b>359.00</b>
48	24	87	450	QC5-4824S◆	150.0	<b>445.00</b>	QC5-4824A◆	136.0	<b>403.00</b>
<b>6 SHELVES</b>									
36	12	87	750	QC6-3612S◆	95.0	<b>299.00</b>	QC6-3612A◆	89.0	<b>279.00</b>
36	18	87	750	QC6-3618S◆	116.0	<b>357.00</b>	QC6-3618A◆	106.0	<b>324.00</b>
36	24	87	700	QC6-3624S◆	136.0	<b>411.00</b>	QC6-3624A◆	122.0	<b>369.00</b>
48	12	87	500	QC6-4812S◆	116.0	<b>359.00</b>	QC6-4812A◆	110.0	<b>339.00</b>
48	18	87	500	QC6-4818S◆	141.0	<b>427.00</b>	QC6-4818A◆	131.0	<b>394.00</b>
48	24	87	450	QC6-4824S◆	164.0	<b>487.00</b>	QC6-4824A◆	150.0	<b>445.00</b>
<b>8 SHELVES</b>									
36	12	87	750	QC8-3612S◆	109.0	<b>343.00</b>	QC8-3612A◆	103.0	<b>323.00</b>
36	18	87	750	QC8-3618S◆	134.0	<b>410.00</b>	QC8-3618A◆	124.0	<b>377.00</b>
36	24	87	700	QC8-3624S◆	158.0	<b>476.00</b>	QC8-3624A◆	144.0	<b>434.00</b>
48	12	87	500	QC8-4812S◆	134.0	<b>414.00</b>	QC8-4812A◆	128.0	<b>394.00</b>
48	18	87	500	QC8-4818S◆	163.0	<b>496.00</b>	QC8-4818A◆	153.0	<b>463.00</b>
48	24	87	450	QC8-4824S◆	192.0	<b>570.00</b>	QC8-4824A◆	179.0	<b>528.00</b>

\*Load capacities based on evenly distributed loads.

Starter units include two ends and one back panel; adder units include one end and one back panel.

All posts are Offset Angle Posts (OAP-87).

All shelves are 22 gauge. (20 gauge units also available; call factory for pricing.)



STARTER UNITS



ADDER UNITS

### LEDGE UNIT (With 3 Openings)

◆ QUICKSHIP COLOR: Medium Grey

CAT. NO.	W	D	H	WT.	PRICE
<b>LEDGE UNIT</b>					
ILU-3637◆	36	12	39	45.0	<b>148.00</b>
<b>HINGED DOOR/FRAME FOR LEDGE UNIT</b>					
HD-3638RH◆	36	1 1/4	38	28.0	<b>235.00</b>

\*Ordering optional hinged door for unit adds 1 1/4" door frame depth and 1/2" handle depth. Hinged door for ledge unit comes standard with one recessed handle.



87" Q-Line Unit with Ledge Unit attached.



87" Q-Line Unit with Ledge Unit and Optional Hinged Door and Frame attached.



Look for the red diamond!

**BOX FORM SHELVES**

# Q-LINE SHELVING Shelves

CAT. NO.	LOAD CAP.†	W	D	H	WT.	PRICE
<b>20 GAUGE SOLID SHELVES</b>						
Q-3612♦	1000	36	12	1 5/16	8.0	<b>25.00</b>
Q-3615*♦	900	36	15	1 5/16	9.3	<b>32.00</b>
Q-3618♦	850	36	18	1 5/16	10.5	<b>32.00</b>
Q-3624♦	800	36	24	1 5/16	13.0	<b>39.00</b>
Q-3630*♦	800	36	30	1 5/16	15.4	<b>53.00</b>
Q-3636*♦	600	36	36	1 5/16	17.9	<b>63.00</b>
Q-4212*	800	42	12	1 5/16	9.2	<b>31.00</b>
Q-4215*	700	42	15	1 5/16	10.6	<b>39.00</b>
Q-4218♦	650	42	18	1 5/16	12.0	<b>39.00</b>
Q-4224♦	650	42	24	1 5/16	14.9	<b>48.00</b>
Q-4230*	600	42	30	1 5/16	17.7	<b>59.00</b>
Q-4236*	550	42	36	1 5/16	21.0	<b>69.00</b>
Q-4812♦	650	48	12	1 5/16	10.4	<b>32.00</b>
Q-4815*	600	48	15	1 5/16	12.0	<b>43.00</b>
Q-4818♦	550	48	18	1 5/16	13.6	<b>40.00</b>
Q-4824♦	550	48	24	1 5/16	16.8	<b>49.00</b>
Q-4830*	500	48	30	1 5/16	19.9	<b>66.00</b>
Q-4836*♦	450	48	36	1 5/16	23.0	<b>76.00</b>
<b>20 GAUGE SOLID SHELVES WITH STIFFENERS**</b>						
Q-3624-S*	1000	36	24	1 5/16	15.4	<b>57.00</b>
Q-3630-S*	1000	36	30	1 5/16	18.1	<b>72.00</b>
Q-3636-S*	750	36	36	1 5/16	21.0	<b>84.00</b>
Q-4224-S*	800	42	24	1 5/16	17.6	<b>67.00</b>
Q-4230-S*	750	42	30	1 5/16	21.0	<b>80.00</b>
Q-4236-S*	700	42	36	1 5/16	24.0	<b>91.00</b>
Q-4824-S*	700	48	24	1 5/16	19.8	<b>74.00</b>
Q-4830-S*	650	48	30	1 5/16	23.0	<b>87.00</b>
Q-4836-S*	600	48	36	1 5/16	27.0	<b>98.00</b>
<b>22 GAUGE SOLID SHELVES</b>						
Q2-3612♦	750	36	12	1 5/16	6.7	<b>22.00</b>
Q2-3615*♦	750	36	15	1 5/16	7.8	<b>28.00</b>
Q2-3618♦	750	36	18	1 5/16	8.8	<b>27.00</b>
Q2-3624♦	700	36	24	1 5/16	10.9	<b>33.00</b>
Q2-3630*♦	600	36	30	1 5/16	12.9	<b>47.00</b>
Q2-4212*♦	600	42	12	1 5/16	7.7	<b>28.00</b>
Q2-4215*♦	600	42	15	1 5/16	8.9	<b>34.00</b>
Q2-4218♦	600	42	18	1 5/16	10.1	<b>35.00</b>
Q2-4224♦	550	42	24	1 5/16	12.5	<b>42.00</b>
Q2-4230*♦	500	42	30	1 5/16	14.8	<b>52.00</b>
Q2-4812♦	500	48	12	1 5/16	8.7	<b>28.00</b>
Q2-4815*♦	500	48	15	1 5/16	10.1	<b>36.00</b>
Q2-4818♦	500	48	18	1 5/16	11.4	<b>35.00</b>
Q2-4824♦	450	48	24	1 5/16	14.1	<b>42.00</b>
Q2-4830*♦	400	48	30	1 5/16	16.7	<b>61.00</b>
<b>22 GAUGE PERFORATED SHELVES</b>						
PQ2-3612P	450	36	12	1 5/16	5.8	<b>26.00</b>
PQ2-3615P	450	36	15	1 5/16	6.7	<b>37.00</b>
PQ2-3618P	450	36	18	1 5/16	7.5	<b>36.00</b>
PQ2-3624P	400	36	24	1 5/16	9.2	<b>43.00</b>
PQ2-3630P	350	36	30	1 5/16	9.4	<b>48.00</b>
PQ2-4215P	375	42	15	1 5/16	7.6	<b>34.00</b>
PQ2-4224P	325	42	24	1 5/16	10.5	<b>43.00</b>
PQ2-4230P	275	42	30	1 5/16	12.9	<b>58.00</b>
PQ2-4812P	300	48	12	1 5/16	7.4	<b>32.00</b>
PQ2-4815P	300	48	15	1 5/16	8.5	<b>37.00</b>
PQ2-4818P	300	48	18	1 5/16	9.6	<b>41.00</b>
PQ2-4824P	250	48	24	1 5/16	11.7	<b>50.00</b>
PQ2-4830P	200	48	30	1 5/16	13.9	<b>57.00</b>
PQ2-4836P	175	48	36	1 5/16	16.2	<b>74.00</b>

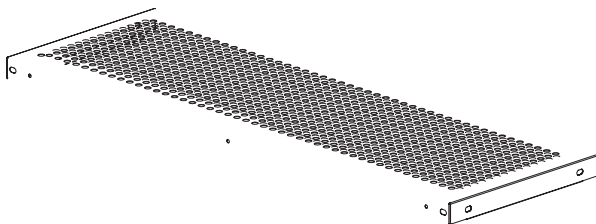



# Q-LINE SHELVING

## Posts, Uprights, Label Holders, Shelf Clips

Look for the red diamond! 

### UPRIGHT POSTS

◆ QUICKSHIP COLOR: Medium Grey

CAT. NO.	QTY.	W	D	H	WT.	PRICE
<b>OFFSET ANGLE POST</b>						
OAP-39	12	1	1 7/8	39	2.4	<b>6.70</b>
OAP-48	12	1	1 7/8	48	2.9	<b>8.10</b>
OAP-51	12	1	1 7/8	51	3.1	<b>8.70</b>
OAP-75◆	12	1	1 7/8	75	4.6	<b>12.30</b>
OAP-84◆	12	1	1 7/8	84	5.1	<b>13.60</b>
OAP-87◆	12	1	1 7/8	87	5.3	<b>14.00</b>
OAP-96	12	1	1 7/8	96	5.9	<b>15.50</b>
OAP-99◆	12	1	1 7/8	99	6.0	<b>16.10</b>
OAP-108	12	1	1 7/8	108	6.8	<b>20.00</b>
OAP-111◆	12	1	1 7/8	111	6.8	<b>18.10</b>
OAP-123◆	12	1	1 7/8	123	7.5	<b>20.00</b>
<b>BEADED T-POST</b>						
BTP-39	5	3/8	1 7/8	39	2.7	<b>10.30</b>
BTP-48	5	3/8	1 7/8	48	3.4	<b>12.40</b>
BTP-51	5	3/8	1 7/8	51	3.6	<b>13.10</b>
BTP-75◆	5	3/8	1 7/8	75	5.3	<b>17.90</b>
BTP-84◆	5	3/8	1 7/8	84	5.9	<b>20.00</b>
BTP-87◆	5	3/8	1 7/8	87	6.1	<b>20.00</b>
<b>EXTRA HEAVY DUTY BEADED T-POST</b>						
HBP-39	5	3/4	2 7/8	39	4.4	<b>26.00</b>
HBP-48	5	3/4	2 7/8	48	5.4	<b>28.00</b>
HBP-51	5	3/4	2 7/8	51	5.7	<b>33.00</b>
HBP-75	5	3/4	2 7/8	75	8.4	<b>36.00</b>
HBP-84◆	5	3/4	2 7/8	84	9.4	<b>38.00</b>
HBP-87◆	5	3/4	2 7/8	87	9.8	<b>38.00</b>
HBP-99◆	5	3/4	2 7/8	99	11.1	<b>40.00</b>
HBP-111	5	3/4	2 7/8	111	12.5	<b>45.00</b>
HBP-123	5	3/4	2 7/8	123	13.9	<b>49.00</b>

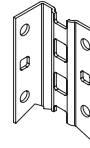

OFFSET ANGLE POST

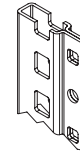

BEADED T-POST



EXTRA HEAVY DUTY BEADED POST

Post slotted for shelf adjustment on 1" centers. Total weight capacity not to exceed 5,000 lbs. per unit for OAP and HBP posts. Weight capacity not to exceed 3,500 lbs per unit for BTP posts. Capacities based upon 24" shelf centers or less.

### WELDED UPRIGHTS

DEPTH	CAT. NO.	H	WT.	PRICE
12" DEEP	WU-1239	39	7.1	<b>38.00</b>
	WU-1251	51	9.3	<b>45.00</b>
	WU-1275	75	13.7	<b>58.00</b>
	WU-1284	84	15.3	<b>61.00</b>
	WU-1287	87	15.8	<b>64.00</b>
15" DEEP	WU-1539	39	8.0	<b>40.00</b>
	WU-1551	51	10.5	<b>47.00</b>
	WU-1575	75	15.5	<b>62.00</b>
	WU-1584	84	17.3	<b>68.00</b>
18" DEEP	WU-1587	87	17.9	<b>70.00</b>
	WU-1839	39	9.1	<b>42.00</b>
	WU-1851	51	11.9	<b>50.00</b>
	WU-1875	75	17.3	<b>68.00</b>
18" DEEP	WU-1884	84	19.6	<b>73.00</b>
	WU-1887	87	20.3	<b>75.00</b>

DEPTH	CAT. NO.	H	WT.	PRICE
24" DEEP	WU-2439	39	10.3	<b>47.00</b>
	WU-2451	51	13.4	<b>57.00</b>
	WU-2475	75	19.7	<b>81.00</b>
	WU-2484	84	22.1	<b>87.00</b>
	WU-2487	87	22.9	<b>89.00</b>
30" DEEP	WU-3039	39	11.5	<b>53.00</b>
	WU-3051	51	15.1	<b>64.00</b>
	WU-3075	75	22.1	<b>94.00</b>
	WU-3084	84	24.8	<b>101.00</b>
	WU-3087	87	25.7	<b>105.00</b>
36" DEEP	WU-3639	39	13.0	<b>58.00</b>
	WU-3651	51	17.0	<b>71.00</b>
	WU-3675	75	25.0	<b>104.00</b>
	WU-3684	84	28.0	<b>112.00</b>
	WU-3687	87	29.0	<b>116.00</b>

These are panels attached to OAP style posts. For quantities of less than 50 pieces, add \$100/list setup charge. Contact factory for pricing on intermediate welded uprights.

◆ QUICKSHIP COLOR: Medium Grey

CAT. NO.	W	D	H	WT.	PRICE
LH-36◆	36	3/16	7/8	0.3	<b>2.50</b>
LH-42	42	3/16	7/8	0.4	<b>2.70</b>
LH-48◆	48	3/16	7/8	0.5	<b>2.90</b>

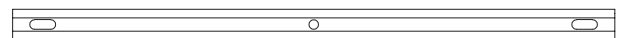

Attachment plugs included.

### SHELF LABEL HOLDER

CAT. NO.	W	D	H	WT.	PRICE
T-1	1	1/2	2 3/4	0.1	<b>.48</b>



Attaches shelves to uprights. Shelf clips are Zinc Plated.

### REPLACEMENT SHELF CLIPS

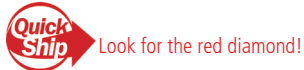

### BIN DIVIDERS

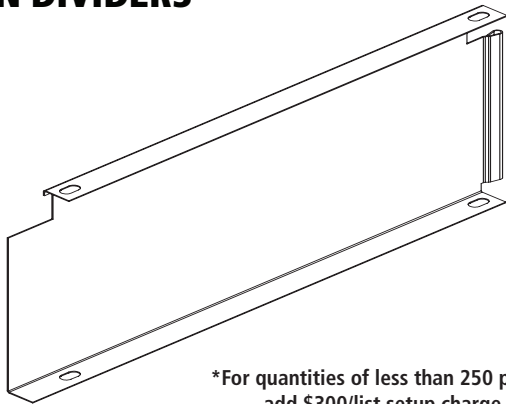

\*For quantities of less than 250 pieces, add \$300/list setup charge.

◆ QUICKSHIP COLOR: Medium Grey

CAT. NO.	W	D	H	WT.	PRICE
<b>12" DEEP</b>					
BD-1206◆	7/32	12	6	0.6	<b>3.80</b>
BD-1209◆	7/32	12	9	1.0	<b>4.70</b>
BD-1212◆	7/32	12	12	1.3	<b>7.10</b>
BD-1215*	7/32	12	15	1.6	<b>7.00</b>
BD-1218	7/32	12	18	1.9	<b>7.50</b>
<b>15" DEEP</b>					
BD-1506*	7/32	15	6	1.0	<b>5.70</b>
BD-1509*	7/32	15	9	1.3	<b>6.50</b>
BD-1512*	7/32	15	12	1.8	<b>8.00</b>
BD-1515*	7/32	15	15	2.0	<b>9.50</b>
BD-1518*	7/32	15	18	2.7	<b>10.80</b>
<b>18" DEEP</b>					
BD-1806	7/32	18	6	1.2	<b>5.70</b>
BD-1809	7/32	18	9	1.5	<b>6.50</b>
BD-1812◆	7/32	18	12	2.0	<b>8.00</b>
BD-1815	7/32	18	15	2.5	<b>9.50</b>
BD-1818	7/32	18	18	3.0	<b>10.80</b>

### BIN FRONTS

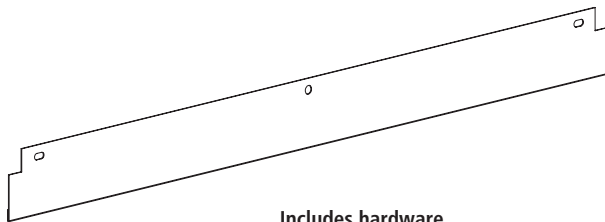

Includes hardware.

◆ QUICKSHIP COLOR: Medium Grey

CAT. NO.	W	D	H	WT.	PRICE
BF-362◆	36	3/64	2	1.3	<b>7.10</b>
BF-422	42	3/64	2	1.5	<b>7.80</b>
BF-482	48	3/64	2	1.7	<b>8.50</b>

### END SWAY BRACES (sold in pairs)

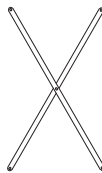

◆ QUICKSHIP COLOR: Medium Grey

CAT. NO.	SHELF DEPTH	WT.	PRICE
ESB-1224◆	12" to 24"	2.4	<b>8.10</b>
ESB-3036◆	30" to 36"	3.1	<b>9.50</b>

Includes hardware. NOTE: Use two pair for uprights 96"-137" and three pair for uprights 138" and higher.

### REAR SWAY BRACES (Sold In Pairs)

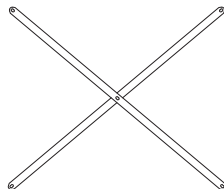

◆ QUICKSHIP COLOR: Medium Grey

CAT. NO.	UNIT LENGTH	WT.	PRICE
RSBU◆	36" to 42"	3.2	<b>10.10</b>
RSB-48◆	48"	3.7	<b>10.50</b>

Includes hardware. NOTE: Use two pair for uprights 96"-137" and three pair for uprights 138" and higher.

### END SWAY PLATES

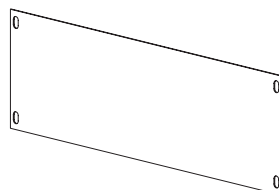

CAT. NO.	W	D	H	WT.	PRICE
ESP-12	—	12 5/8	5	1.2	<b>6.20</b>
ESP-18	—	18 5/8	5	2.0	<b>8.10</b>
ESP-24	—	24 5/8	5	2.8	<b>10.00</b>

# Q-LINE SHELVING

## End/Back Panels, Sliding Dividers, Foot Plates

Look for the red diamond!

### BACK AND END PANELS

◆ QUICKSHIP COLOR: Medium Grey

BACK PANELS				
WIDTH	CAT. NO.	H	WT.	PRICE
36" WIDE 	BP-3639	39	9.8	36.00
	BP-3648	48	12.1	42.00
	BP-3651◆	51	12.9	44.00
	BP-3675◆	75	18.9	62.00
	BP-3684◆	84	21.0	69.00
42" WIDE* 	BP-4239	39	11.8	45.00
	BP-4248	48	14.5	52.00
	BP-4251	51	15.4	56.00
	BP-4275	75	23.0	77.00
	BP-4284◆	84	25.0	86.00
48" WIDE* 	BP-4839	39	14.0	50.00
	BP-4848	48	17.0	59.00
	BP-4851◆	51	18.1	63.00
	BP-4875◆	75	27.0	86.00
	BP-4884◆	84	30.0	96.00
	BP-4887◆	87	31.0	95.00

\*42" and 48" backs consist of two pieces. Hardware included.

◆ QUICKSHIP COLOR: Medium Grey

END PANELS				
DEPTH	CAT. NO.	H	WT.	PRICE
12" DEEP 	EP-1239	39	2.7	11.00
	EP-1248	48	3.3	13.70
	EP-1251◆	51	3.5	14.40
	EP-1275◆	75	5.1	19.70
	EP-1284◆	84	5.7	22.00
15" DEEP 	EP-1539	39	3.7	14.20
	EP-1548	48	4.5	16.50
	EP-1551◆	51	4.8	17.30
	EP-1575◆	75	7.1	24.00
	EP-1584◆	84	7.9	27.00
18" DEEP 	EP-1839	39	4.5	16.90
	EP-1848	48	5.5	19.80
	EP-1851◆	51	5.9	21.00
	EP-1875◆	75	8.6	29.00
	EP-1884◆	84	9.6	33.00
24" DEEP 	EP-1887◆	87	10.0	33.00
	EP-2439	39	6.8	22.00
	EP-2448	48	7.5	26.00
	EP-2451◆	51	8.0	26.00
	EP-2475◆	75	11.7	39.00
30" DEEP 	EP-2484◆	84	13.1	44.00
	EP-2487◆	87	13.6	42.00
	EP-3039	39	7.9	25.00
	EP-3048	48	9.7	30.00
	EP-3051	51	10.3	33.00
36" DEEP 	EP-3075	75	15.2	46.00
	EP-3084	84	17.0	51.00
	EP-3087	87	17.6	53.00
	EP-3639	39	9.8	30.00
	EP-3648	48	12.1	36.00
	EP-3651	51	12.9	39.00
	EP-3675	75	18.9	55.00
	EP-3684	84	21.0	61.00
	EP-3687	87	22.0	63.00

DEPTH	CAT. NO.	H	WT.	PRICE
12" DEEP 	SD-1230	3.0	0.7	8.10
	SD-1245	4.5	0.9	8.70
	SD-1260	6.0	1.0	9.40
18" DEEP 	SD-1830	3.0	1.1	9.80
	SD-1845	4.5	1.4	10.70
	SD-1860	6.0	1.6	11.60
24" DEEP 	SD-2430	3.0	1.5	10.90
	SD-2445	4.5	1.8	12.00
	SD-2460	6.0	2.0	13.20

### SLIDING DIVIDERS

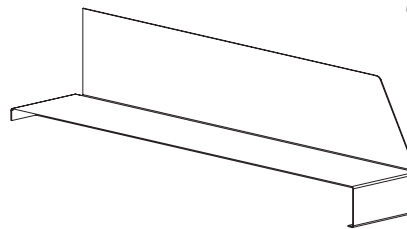

CAT. NO.	W	D	H	WT.	PRICE
FP-1	1 1/2	1/16	2 1/4	0.1	.74

Used to secure uprights to the floor.

NOTE: Seismic foot plate is also available, below.

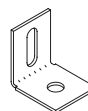

### FOOT PLATE

CAT. NO.	W	D	H	WT.	PRICE
IFP-1	3 1/4	1 5/8	2 1/2	0.4	4.00

Order one foot plate for each OAP upright and two foot plates back-to-back for each HBP upright, as shown.

When seismic foot is used, bottom shelf is 6 9/32" above floor.

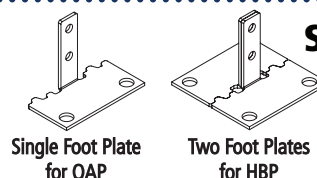

### SEISMIC FOOT PLATE

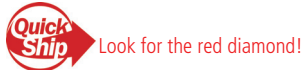

**SHELF BOXES**

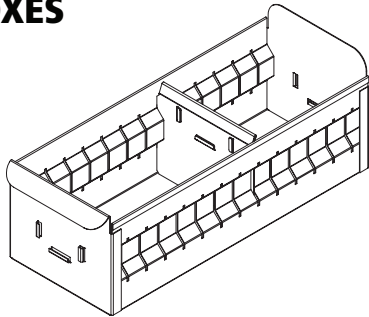

CAT. NO.	QTY.	W	D	H	WT.	PRICE
BX-512	12	5 5/8	11	4 9/16	2.5	<b>14.00</b>
BX-518	12	5 5/8	17	4 9/16	3.3	<b>17.10</b>
BX-812	12	8 3/8	11	4 9/16	3.5	<b>16.70</b>
BX-818	12	8 3/8	17	4 9/16	4.3	<b>19.80</b>
BX-1112	12	11 1/4	11	4 9/16	4.5	<b>20.00</b>
BX-1118	12	11 1/4	17	4 9/16	5.3	<b>25.00</b>

One pair of shelf box guides (sold below) per shelf is recommended. Heights shown are for box front; shelves may be spaced on 6" increments. Comes with one shelf box divider.

**SHELF BOX GUIDES**

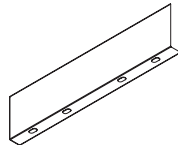

CAT. NO.	SHELF DEPTH	W	D	H	WT.	PRICE
BXG-12	12	11 7/8	3/4	2 3/4	0.8	<b>10.70</b>
BXG-18	18	17 7/8	3/4	2 3/4	1.0	<b>11.80</b>

Priced per pair. Includes hardware.

**SHELF BOX DIVIDERS (Galvanized)**

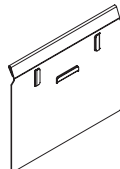

♦ QUICKSHIP COLOR: Galvanized

CAT. NO.	W	D	H	WT.	PRICE
BXD-5♦	5 3/16	1/32	4 1/2	0.2	<b>1.00</b>
BXD-8♦	8	1/32	4 1/2	0.3	<b>1.30</b>
BXD-11♦	10 7/8	1/32	4 1/2	0.4	<b>1.70</b>

**FRONT BASE STRIP**

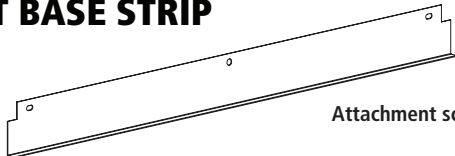

Attachment screws included.

♦ QUICKSHIP COLOR: Medium Grey

CAT. NO.	W	D	H	WT.	PRICE
FBS-362♦	36	1/2	1 7/8	1.2	<b>7.30</b>
FBS-422♦	42	1/2	1 7/8	1.5	<b>7.80</b>
FBS-482♦	48	1/2	1 7/8	1.7	<b>8.40</b>

**MEZZANINE BRACKETS**

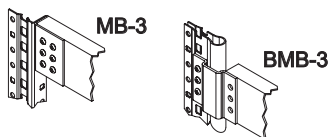

Includes hardware.

CAT. NO.	W	D	H	WT.	PRICE
<b>FOR OFFSET ANGLE POST</b>					
MB-3	1 1/16	2 1/4	3	0.5	<b>3.50</b>
<b>FOR HEAVY DUTY BEADED POST</b>					
BMB-3	15/32	3 13/16	3	0.5	<b>4.40</b>

**GUSSETS**

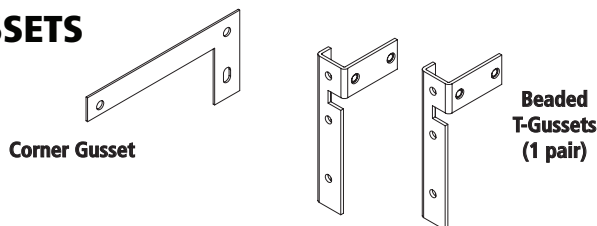

Corner Gusset

Beaded T-Gussets (1 pair)

CAT. NO.	DESCRIPTION	WT.	PRICE
AG-6	CORNER GUSSET (ea.)	0.1	<b>2.80</b>
BG-6	BEADED T GUSSET (pr.)	0.2	<b>12.50</b>

Can be used in place of sway braces.

**SPLICE PLATES**

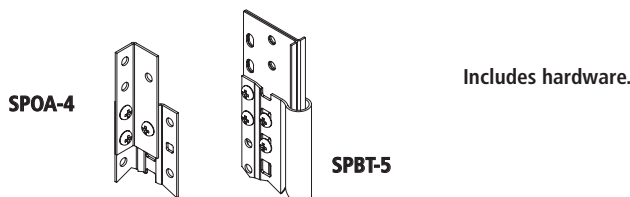

SPOA-4

SPBT-5

Includes hardware.

CAT. NO.	W	D	H	WT.	PRICE
<b>FOR OFFSET ANGLE POST</b>					
SPOA-4	27/32	1 1/8	4	0.3	<b>3.20</b>
<b>FOR HEAVY DUTY BEADED POST</b>					
SPBT-5	5/8	2 7/16	5	0.5	<b>9.90</b>

# AUTOMOTIVE SHELVING

## Preconfigured Units & Components

Look for the red diamond! 

### AUTOMOTIVE SHELVING UNITS

CAT. NO.	# OF SHELVES	W	D	H	WT.	PRICE
P-S84	—	38	12	84	78.0	<b>244.00</b>
P-8401	6	38	12	84	114.0	<b>340.00</b>
P-8411	12	38	12	84	150.0	<b>436.00</b>
P-8417*	—	38	12	84	396.0	<b>2,892.00</b>

\* Unit includes 108 bin boxes.

Units include back but no end panels. Order end panels separately to provide flush, finished ends for rows. Dimensions shown are outside dimensions.

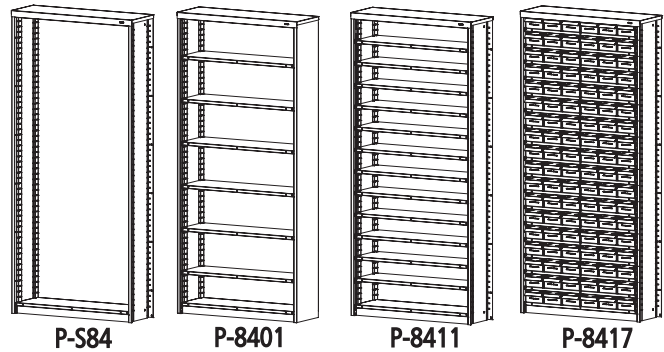

CAT. NO.	W	D	H	WT.	PRICE
P-1242	15 <sup>15</sup> / <sub>16</sub>	12	42	16.0	<b>61.00</b>
P-1284	15 <sup>15</sup> / <sub>16</sub>	12	84	31.8	<b>102.00</b>
P-1296	15 <sup>15</sup> / <sub>16</sub>	12	96	36.0	<b>113.00</b>

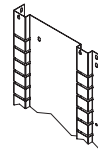

### UPRIGHTS (Sold In Pairs)

CAT. NO.	W	D	H	WT.	PRICE
P-42E	1 1 <sup>1</sup> / <sub>16</sub>	12 3 <sup>3</sup> / <sub>32</sub>	42	11.0	<b>30.00</b>
P-84E	1 1 <sup>1</sup> / <sub>16</sub>	12 3 <sup>3</sup> / <sub>32</sub>	84	22.0	<b>60.00</b>
P-96E	1 1 <sup>1</sup> / <sub>16</sub>	12 3 <sup>3</sup> / <sub>32</sub>	96	25.0	<b>72.00</b>

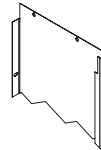

### END PANELS (Sold In Pairs)

CAT. NO.	W	D	H	WT.	PRICE
P-3842	37 3 <sup>3</sup> / <sub>4</sub>	12	42	17.3	<b>51.00</b>
P-3884	37 3 <sup>3</sup> / <sub>4</sub>	12	84	32.9	<b>93.00</b>
P-3896	37 3 <sup>3</sup> / <sub>4</sub>	12	96	37.6	<b>108.00</b>

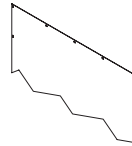

### BACKS

When placing units back to back (as in double-face application), units may share a common back.

CAT. NO.	W	D	H	WT.	PRICE
<b>BIN BOX</b>					
P-55	5 1 <sup>1</sup> / <sub>2</sub>	12	3 1 <sup>1</sup> / <sub>4</sub>	2.0	<b>22.00</b>
<b>BIN BOX DIVIDER</b>					
P-55D	5 3 <sup>3</sup> / <sub>16</sub>	1 1 <sup>1</sup> / <sub>32</sub>	2 9 <sup>9</sup> / <sub>16</sub>	0.1	<b>1.20</b>

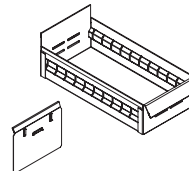

### BIN BOXES

CAT. NO.	W	D	H	WT.	PRICE
P-30	3	12	3	0.7	<b>7.30</b>
P-45	3	12	4 1 <sup>1</sup> / <sub>2</sub>	0.9	<b>7.80</b>
P-60	3	12	6	1.0	<b>7.70</b>

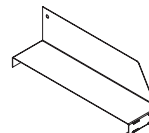

### ADJUSTABLE DIVIDERS

CAT. NO.	W	D	H	WT.	PRICE
<b>TOP</b>					
P-1238	37 7 <sup>7</sup> / <sub>8</sub>	12 1 <sup>1</sup> / <sub>8</sub>	1 1 <sup>1</sup> / <sub>8</sub>	6.3	<b>24.00</b>
<b>BOTTOM</b>					
P-12B	36	11 7 <sup>7</sup> / <sub>8</sub>	3 1 <sup>1</sup> / <sub>16</sub>	7.0	<b>25.00</b>
<b>SHELF</b>					
P-12	35 7 <sup>7</sup> / <sub>8</sub>	11 7 <sup>7</sup> / <sub>8</sub>	7 <sup>7</sup> / <sub>8</sub>	6.0	<b>16.00</b>

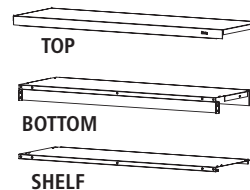

### TOPS, BOTTOMS, SHELVES

CAT. NO.	W	D	H	WT.	PRICE
<b>SHORT WIDTH - USE BETWEEN DIVIDERS</b>					
P-3	3	—	3 <sup>3</sup> / <sub>4</sub>	0.1	<b>.74</b>
<b>FULL SHELF-WIDTH (Includes hardware)</b>					
P-38	33 1 <sup>1</sup> / <sub>4</sub>	11 1 <sup>1</sup> / <sub>64</sub>	7 <sup>7</sup> / <sub>8</sub>	0.3	<b>2.30</b>
<b>FASTENER FOR FULL SHELF-WIDTH HOLDERS</b>					
P-38F	—	—	—	0.1	<b>.11</b>

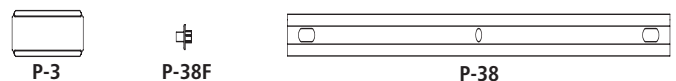

### LABEL HOLDERS

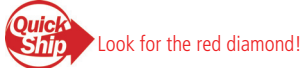

### UPRIGHT FRAMES (FULLY WELDED CONSTRUCTION)

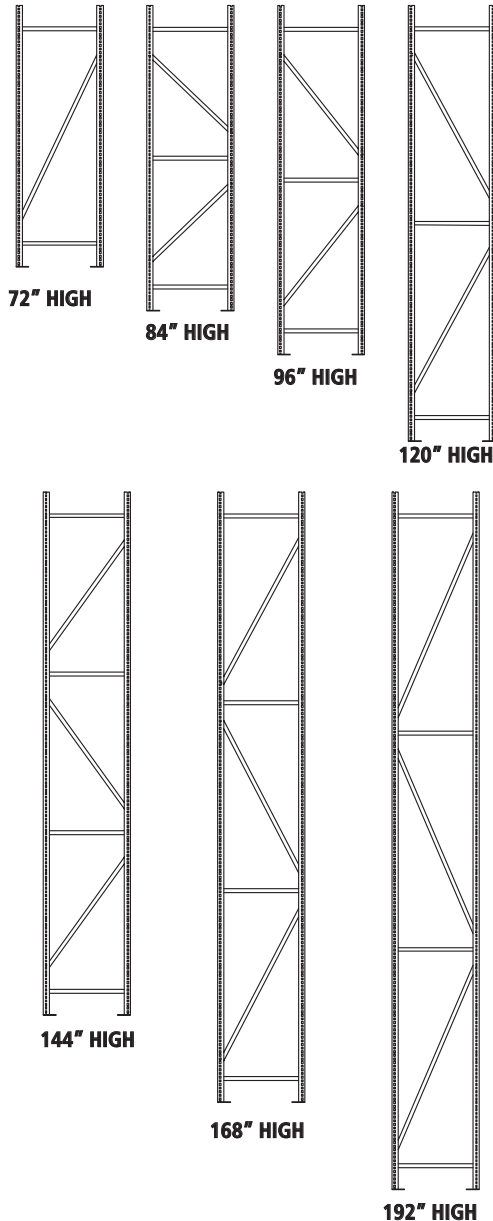

◆ QUICKSHIP COLOR: Medium Grey

CAT. NO.	W	D	H	WT.	PRICE
<b>72" HIGH</b>					
BUF-2472◆	1 3/4	24	72	20.0	<b>66.00</b>
BUF-3072*	1 3/4	30	72	21.0	<b>94.00</b>
BUF-3672◆	1 3/4	36	72	22.0	<b>72.00</b>
BUF-4272*	1 3/4	42	72	22.0	<b>100.00</b>
BUF-4872◆	1 3/4	48	72	23.0	<b>78.00</b>
<b>84" HIGH</b>					
BUF-2484	1 3/4	24	84	24.0	<b>92.00</b>
BUF-3684◆	1 3/4	36	84	25.0	<b>101.00</b>
BUF-4884	1 3/4	48	84	27.0	<b>110.00</b>
<b>96" HIGH</b>					
BUF-2496◆	1 3/4	24	96	28.0	<b>88.00</b>
BUF-3096*	1 3/4	30	96	29.0	<b>105.00</b>
BUF-3696◆	1 3/4	36	96	30.0	<b>99.00</b>
BUF-4296*	1 3/4	42	96	32.0	<b>118.00</b>
BUF-4896◆	1 3/4	48	96	33.0	<b>108.00</b>
<b>120" HIGH</b>					
BUF-24120◆	1 3/4	24	120	33.0	<b>111.00</b>
BUF-30120*	1 3/4	30	120	35.0	<b>150.00</b>
BUF-36120◆	1 3/4	36	120	36.0	<b>116.00</b>
BUF-42120*	1 3/4	42	120	37.0	<b>160.00</b>
BUF-48120◆	1 3/4	48	120	38.0	<b>125.00</b>
<b>144" HIGH</b>					
BUF-24144*	1 3/4	24	144	40.0	<b>158.00</b>
BUF-36144*	1 3/4	36	144	43.0	<b>169.00</b>
BUF-48144*	1 3/4	48	144	46.0	<b>177.00</b>
<b>168" HIGH</b>					
BUF-24168*	1 3/4	24	168	46.0	<b>189.00</b>
BUF-36168*	1 3/4	36	168	50.0	<b>199.00</b>
BUF-48168*	1 3/4	48	168	53.0	<b>208.00</b>
<b>192" HIGH</b>					
BUF-24192*	1 3/4	24	192	53.0	<b>209.00</b>
BUF-36192*	1 3/4	36	192	57.0	<b>215.00</b>

\*For quantities of less than 50 uprights, add \$250 list setup charge.  
17,000 lb. capacity based on maximum vertical distance of 24" between any two beams on floor. Other sizes, up to 54" d x 192" h, are available. Contact factory for pricing.

Punched to accept box formed shelves (Page 16).

### RACK SPACER

Used to attach back-to-back units.  
Maintains a 6" gap to meet fire codes.

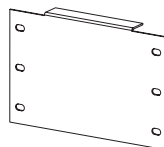

CAT. NO.	W	D	H	WT.	PRICE
BRS-6	8 29/32	1	5 13/16	1.0	<b>10.20</b>

### H-FRAME UPRIGHT EXTENSION

Used to splice two bulk frames together for additional height.



Top upright must be ordered without welded feet.

CAT. NO.	W	D	H	WT.	PRICE
SPBUF-10	8 29/32	1 1/2	5 13/16	3.3	<b>9.10</b>

# BULK STORAGE RACK Components

Look for the red diamond! 

## PLYWOOD BEAM KITS

◆ QUICKSHIP COLOR: Medium Grey

CAT. NO.	W	D	H	WT.	PRICE
BPB-48-24◆	48 1/2	24	3 5/8	18.1	<b>52.00</b>
BPB-48-36◆	48 1/2	36	3 5/8	18.5	<b>56.00</b>
BPB-48-48◆	48 1/2	48	3 5/8	21.0	<b>60.00</b>
BPB-60-24◆	60 1/2	24	3 5/8	21.0	<b>60.00</b>
BPB-60-36◆	60 1/2	36	3 5/8	23.0	<b>64.00</b>
BPB-60-48◆	60 1/2	48	3 5/8	23.0	<b>68.00</b>
BPB-72-24◆	72 1/2	24	3 5/8	25.0	<b>73.00</b>
BPB-72-36◆	72 1/2	36	3 5/8	27.0	<b>78.00</b>
BPB-72-48◆	72 1/2	48	3 5/8	31.0	<b>83.00</b>
BPB-96-24◆	96 1/2	24	3 5/8	34.0	<b>95.00</b>
BPB-96-36◆	96 1/2	36	3 5/8	37.0	<b>102.00</b>
BPB-96-48◆	96 1/2	48	3 5/8	37.0	<b>109.00</b>

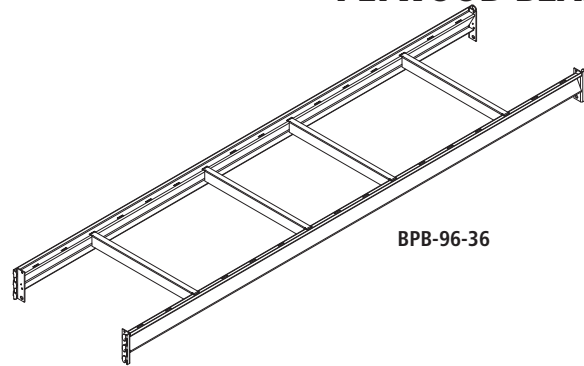

BPB-96-36

Includes 2 plywood beams and required number of support angles needed per level.  
Refer to plywood beam chart (below).

◆ QUICKSHIP COLOR: Medium Grey

## PLYWOOD BEAM (Sold In Pairs)

CAT. NO.	LOAD CAP.	BPS NEEDED (PER LEVEL) TO ACHIEVE LOAD CAPACITY					W	D	H	WT.	PRICE
		24" DEEP	30" DEEP	36" DEEP	42" DEEP	48" DEEP					
BPB-48◆	4150*	2	3	4	6	8	48 1/2	1 1/2	3 5/8	14.7	<b>44.00</b>
BPB-60◆	3800*	2	2	4	5	6	60 1/2	1 1/2	3 5/8	18.0	<b>52.00</b>
BPB-72◆	2750*	3	3	3	3	3	72 1/2	1 1/2	3 5/8	23.0	<b>60.00</b>
BPB-96◆	2150*	4	4	4	4	4	96 1/2	1 1/2	3 5/8	27.0	<b>78.00</b>

\*Capacity calculated for a evenly distributed load using the recommended number of plywood support angles (BPS-dd), sold below

Plywood beams are sold as pairs, and are slotted on 6" centers for deck support angles.



Safety plugs (included) are inserted in each end of the beam to secure posts.

◆ QUICKSHIP COLOR: Medium Grey

CAT. NO.	W	D	H	WT.	PRICE
BPS-24◆	1	24	1 15/16	1.3	<b>4.20</b>
BPS-30	1	30	1 15/16	1.7	<b>5.90</b>
BPS-36◆	1	36	1 15/16	2.1	<b>6.00</b>
BPS-42	1	42	1 15/16	2.3	<b>7.70</b>
BPS-48◆	1	48	1 15/16	2.7	<b>7.80</b>

## PLYWOOD SUPPORT ANGLE



Used for front-to-back support.

◆ QUICKSHIP COLOR: Natural

CAT. NO.	W	D	WT.	PRICE
PB-4824◆	48	24	20.0	<b>14.70</b>
PB-4830◆	48	30	25.0	<b>19.90</b>
PB-4836◆	48	36	31.0	<b>22.00</b>
PB-4842	48	42	35.0	<b>34.00</b>
PB-4848◆	48	48	40.0	<b>32.00</b>
PB-6024◆	60	24	25.0	<b>20.00</b>
PB-6030◆	60	30	31.3	<b>24.00</b>
PB-6036◆	60	36	37.5	<b>30.00</b>
PB-6042	60	42	43.8	<b>40.00</b>
PB-6048◆	60	48	50.0	<b>38.00</b>

CAT. NO.	W	D	WT.	PRICE
PB-7224◆	72	24	30.0	<b>26.00</b>
PB-7230◆	72	30	37.5	<b>28.00</b>
PB-7236◆	72	36	45.0	<b>36.00</b>
PB-7242	72	42	52.5	<b>47.00</b>
PB-7248◆	72	48	60.0	<b>47.00</b>
PB-9624◆	96	24	40.0	<b>32.00</b>
PB-9630◆	96	30	50.0	<b>37.00</b>
PB-9636◆	96	36	60.0	<b>48.00</b>
PB-9642	96	42	70.0	<b>64.00</b>
PB-9648◆	96	48	80.0	<b>63.00</b>

## PARTICLEBOARD DECKING (5/8" H)

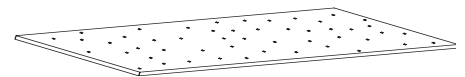

Industrial grade 5/8" thick particleboard provides a sturdy support surface that is both strong and economical.

◆ QUICKSHIP COLOR: Medium Grey

CAT. NO.	W	D	H	WT.	PRICE
ZWD-3624◆	36	24	5/16	8.0	<b>36.00</b>
ZWD-3636◆	36	36	5/16	12.0	<b>49.00</b>
ZWD-4824◆	48	24	5/16	10.7	<b>42.00</b>
ZWD-4836◆	48	36	5/16	16.0	<b>59.00</b>

Wire decking uses 5 gauge wire, & consists of a 2" x 4" mesh pattern. For additional sizes, see page 5.

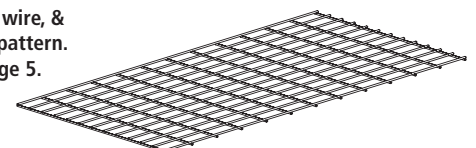

## FLAT WIRE DECKING

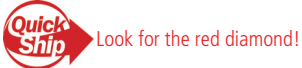

**SADDLE CLIP**

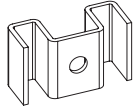

Used to hold down bar grating on a mezzanine. Attaches with one tech screw.

CAT. NO.	W	D	H	WT.	PRICE
SDLC-1	1 23/32	1	1 1/16	0.1	<b>1.10</b>
TECHSCREWS	—	—	—	0.1	<b>.68</b>

**CORRUGATED DECKING**

(9/16" H)

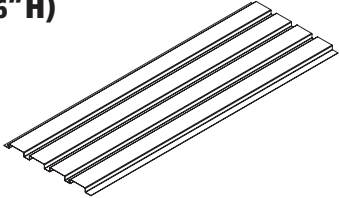

♦ QUICKSHIP COLOR: Medium Grey

CAT. NO.	W	D	WT.	PRICE
BSD-4824♦	48	24	14.0	<b>46.00</b>
BSD-4836♦	48	36	21.0	<b>65.00</b>
BSD-4848♦	48	48	28.0	<b>84.00</b>
BSD-6024♦	60	24	17.9	<b>55.00</b>
BSD-6036♦	60	36	26.0	<b>79.00</b>
BSD-6048♦	60	48	36.0	<b>102.00</b>

CAT. NO.	W	D	WT.	PRICE
BSD-7224♦	72	24	21.0	<b>65.00</b>
BSD-7236♦	72	36	31.0	<b>93.00</b>
BSD-7248♦	72	48	42.0	<b>121.00</b>
BSD-9624♦	96	24	28.0	<b>84.00</b>
BSD-9636♦	96	36	40.0	<b>121.00</b>
BSD-9648♦	96	48	58.0	<b>158.00</b>

Decking is 9/16" high. Comes in 12" w sections.

**BOX BEAM (Sold In Pairs)**

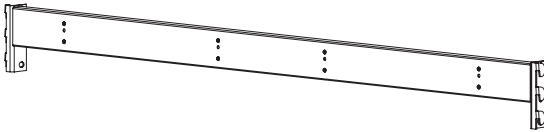

CAT. NO.	LOAD CAP.	W	D	H	WT.	PRICE
BHC-48	2700*	48 1/2	1 1/2	3	12.5	<b>38.00</b>
BHC-60	2500*	60 1/2	1 1/2	3	15.0	<b>52.00</b>
BHC-72	1800*	72 1/2	1 1/2	3	18.1	<b>52.00</b>
BHC-96	1400*	96 1/2	1 1/2	3	22.0	<b>71.00</b>

\*Capacity calculated for uniformly distributed load using recommended number of box beam braces.

**BOX BEAM BRACE**

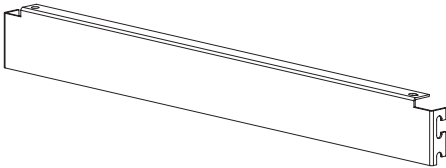

CAT. NO.	W	D	H	WT.	PRICE
SDS-24B	7/8	24	2 11/16	1.9	<b>5.10</b>
SDS-30B	7/8	30	2 11/16	2.4	<b>6.50</b>
SDS-36B	7/8	36	2 11/16	2.8	<b>7.30</b>
SDS-42B	7/8	42	2 11/16	3.3	<b>10.00</b>
SDS-48B	7/8	48	2 11/16	3.9	<b>9.60</b>

Use with BHC-ww. Use two SDS-ddB on 48" and four SDS-ddB on 60", 72" and 96" beams.

**WATERFALL STYLE WIRE DECKING**

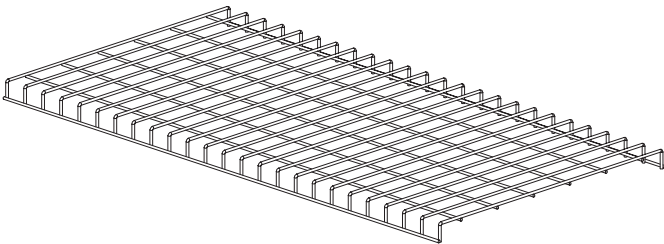

CAT. NO.	W	D	H	WT.	PRICE
BWD-4836	47	36	27/32	17.0	<b>104.00</b>
BWD-4848	47	48	27/32	21.5	<b>110.00</b>

Meets factory mutual codes. 2" x 4" mesh pattern. 2 box beam braces (sold above) required per deck.

Other sizes available, Contact factory for details.

Use with box beams (BHC-ww).

**SLOTTED ANGLE**

**SLOTTED ANGLE**

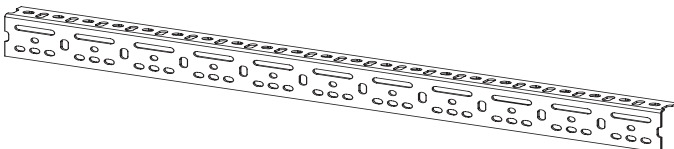

CAT. NO.	GAUGE	LENGTH	WT.	PRICE
BAKED-ON ENAMEL FINISH				
SA-1410P	14	120	7.3	<b>32.00</b>
SA-1412P	14	144	8.8	<b>32.00</b>

Packed 5 per bundle. Includes 38 cadmium plated nuts and bolts.